

LAYHER SYSTEM SOLUTIONS FOR CIVIL ENGINEERING AND BRIDGE CONSTRUCTION



Edition 04.2017
Ref. No. 8116.208

Quality management
certified as per
ISO 9001:2008
by TÜV-CERT

Typical applications,
practical solutions and
useful ideas for Layher
scaffolding systems in
day-to-day use at
the construction site.





COMPANY FROM PAGE 4



Our Location and Philosophy	4
Innovation and Development	6
Production and Quality	8
Service and Expertise	12
Products and Systems	16
Network and Internationality	22

CONSTRUCTION ABOVE GROUND FROM PAGE 24



List	25
Stairways and bridges	26
Reinforcing, concreting and facade scaffolding	30
Shoring for ceiling formwork	34
Noise, dust and weather protection (wintertime construction)	42
Accessories and logistics	46

CONSTRUCTION BELOW GROUND FROM PAGE 48



List	49
Tunnel scaffolding and tunnel trucks	50
Stairway towers – free-standing and suspended	52
Shoring	54



BRIDGE CONSTRUCTION

FROM PAGE 56



List	57
Shoring – TG 60 and heavy-duty towers	58
Work scaffolding – free-standing and suspended	62
Protective enclosures	64
Pillar access – stairway towers in modular design	66
Temporary replacement bridges	68

SPECIAL CONSTRUCTION

FROM PAGE 70



List	71
New silo construction project, Brake	72
Pumped storage power station project, Linthal	74
Dillinger Hütte steelworks project	76
New silo construction project, Harburg	78

SITE EQUIPMENT

FROM PAGE 80



List	81
Advertising signs	82
Cable and pipeline bridges	83
Trench bridges	84
Container accesses	85



Headquarters in Eibensbach

**GOOD SCAFFOLDING IS MADE OF STEEL.
EXCELLENT SCAFFOLDING IS MADE IN
GUEGLINGEN-EIBENSACH.**

LAYHER, THE WORLD'S LEADING MANUFACTURER OF MODULAR SCAFFOLDING SYSTEMS, IS A FAMILY-OWNED COMPANY, WITH ITS ROOTS – AND ITS FUTURE – FIRMLY IN GUEGLINGEN-EIBENSACH.

Layher has its roots in the small town of Gueglingen-Eibensbach in south-west Germany. We are able to deliver made-in-Germany quality by remaining true to those roots – and by keeping development, production, sales, distribution and management in one place, where they have always been: in Gueglingen-Eibensbach.

The headquarters in Eibensbach offers some 250,000 m² of space, including 110,000 m² for production and storage. Manufacturing, development, logistics and administration are in a single location, generating synergies that benefit our customers: seamless information exchange, rapid decision-making, responsiveness, hands-on quality control and much more. Not least, manufacturing processes can be reengineered at any time in response to changing market needs.

MORE SUCCESS THROUGH PARTNERSHIP

“More possibilities” – the Layher brand promise is the modern expression of a traditional dedication to customer service and innovation that has been practiced day in, day out, for generations. And we remain committed to making scaffolding simpler, swifter, and above all safer, by creating ever-better products. Our customers’ success, business sustainability and the conservation of natural resources are key to our business philosophy.

A decision to purchase Layher products is simultaneously a decision in favour of a comprehensive set of services: by delivering more speed, safety, proximity, simplicity and future, we strengthen our customers’ competitiveness. And we do so within the scope of a true partnership, where the focus is on people.

And Layher products are not just sound in terms of our corporate philosophy, they are also sound in terms of their business benefits: our scaffolding is designed to be fully compatible across all our systems, and we guarantee that additional parts and elements are available for purchase not just for years but for decades. What’s more, our products have a deserved reputation for durability that is second to none – adding up to maximum investment protection for our customers around the globe.



MORE INFORMATION

Discover the world of Layher in its company film at:
qrimageen.layher.com



A growing business: in 2009, Layher established a second manufacturing plant just a stone’s throw from the original location in Eibensbach. The Gueglingen facility has a total area of 68,000 m², with 32,000 m² of production and storage space. All aluminium and wooden components are manufactured here.

Plant 2 in Gueglingen



WE HAVE BEEN DOING THE SAME OLD THING FOR MORE THAN SEVEN DECADES: COMING UP WITH SOMETHING NEW.

OUR OVERRIDING PRIORITY IS OUR CUSTOMERS' LASTING SUCCESS. WHICH IS WHY WE CONTINUE TO IMPROVE OUR SCAFFOLDING SYSTEMS.





LAYHER HAS BEEN A LEADER IN PIONEERING AND INNOVATIVE SCAFFOLDING SYSTEMS FOR MORE THAN 70 YEARS NOW.

The Layher SpeedyScaf scaffolding revolutionised scaffolding assembly in 1965 – and Layher Allround Scaffolding has been the groundbreaking modular system on the world market since 1974. The Layher brand is recognized around the world for its quality, safety and efficiency.

Our overriding priority is our customers' lasting success – which is why we continue to improve our scaffolding systems.

OUR PRODUCTS ARE THE RESULT OF HANDS-ON EXPERIENCE AND DESIGNED TO DELIVER PRACTICAL BENEFITS.

Use in everyday work determines the entire development process. In the first step, our engineers create an initial design, taking into account current standards and calculation methods. The next step is to build prototypes that are put through their paces using an in-house test rig and also at selected customer sites – only when they have passed the tests are the prototypes put into production.

INNOVATION IS WHAT ENABLES LAYHER TO PROMISE ITS CUSTOMERS MORE POSSIBILITIES – AND TO DELIVER ON THAT PROMISE.

Layher scaffolding products are durable, compliant with all applicable standards, and fully combinable with one another. The focus of our development work is always on the integration of new products and on improving safety during assembly and dismantling of scaffolding. We also open up new business fields with new products.

LAYHER RESOLVES CONTRADICTIONS

PROFITABILITY AND SAFETY AREN'T CONTRADICTIONS AT LAYHER.

LAYHER LIGHTWEIGHT – THE NEW DIMENSION IN SCAFFOLDING

New materials, new production processes and design improvements to make our systems lighter, faster, stronger – and so even more economical.



WE DON'T JUST TALK ABOUT QUALITY. WE PRODUCE IT. YEAR IN, YEAR OUT.

CAREFULLY CHOSEN MATERIALS, STATE-OF-THE-ART PROCESSES AND PRECISION AUTOMATION TOGETHER DELIVER THE EXCEPTIONAL STANDARDS OF QUALITY KNOWN WORLDWIDE SIMPLY AS "MADE BY LAYHER".



Layher steel decks are manufactured from steel coils that can be up to 1.7 kilometres in length and up to 11 tons in weight. The steel is placed in a special decoiler by means of a crane and a truck. The steel is then fed from this decoiler via a straightening device to an eccentric press with a rated strength of 650 tons.

MAXIMUM PRODUCTION PRECISION

Layher discovered the power of automation many years ago, and since then has extended and refined its use. As a result, the company continues to manufacture its products in Germany, remaining highly competitive while ensuring the high-quality products.

The foundations for automated production go back 30 years, starting with the purchase of the very first semi-automatic welding machines and steel deck shaping systems. Since then, automation has been continually extended and improved, tripling in the last 10 years alone. Recent steps include the construction of a fully automatic hot-dip galvanizing plant, approximately 10,000 square metres in size and having a capacity of 80,000 tons per year.

For all components required in quantities that justify automation, we employ specialist equipment and production lines designed by our own engineers. Robots are employed on a large scale in welding work, for both steel and aluminium parts. This guarantees an exceptionally high degree of precision – and therefore quality. To be absolutely sure, random samples are taken after each step of the production process, and checked for exact compliance with our stringent specifications. This is how we ensure that the parts that are shipped to our customers are free from any defects.

Layher continues to invest in the expansion of highly-automated manufacturing. This means that we can produce competitively in Germany and ensure consistently high quality in our products.

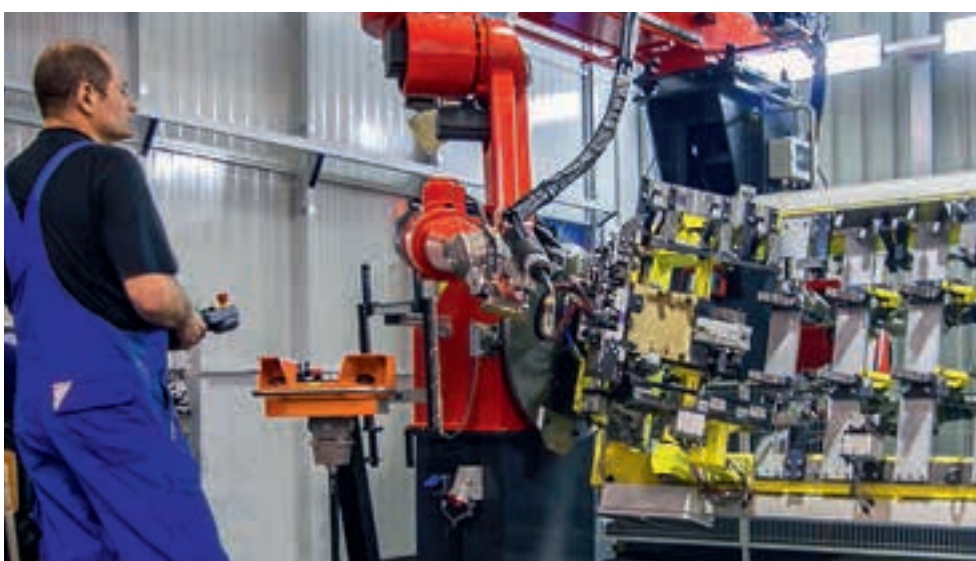

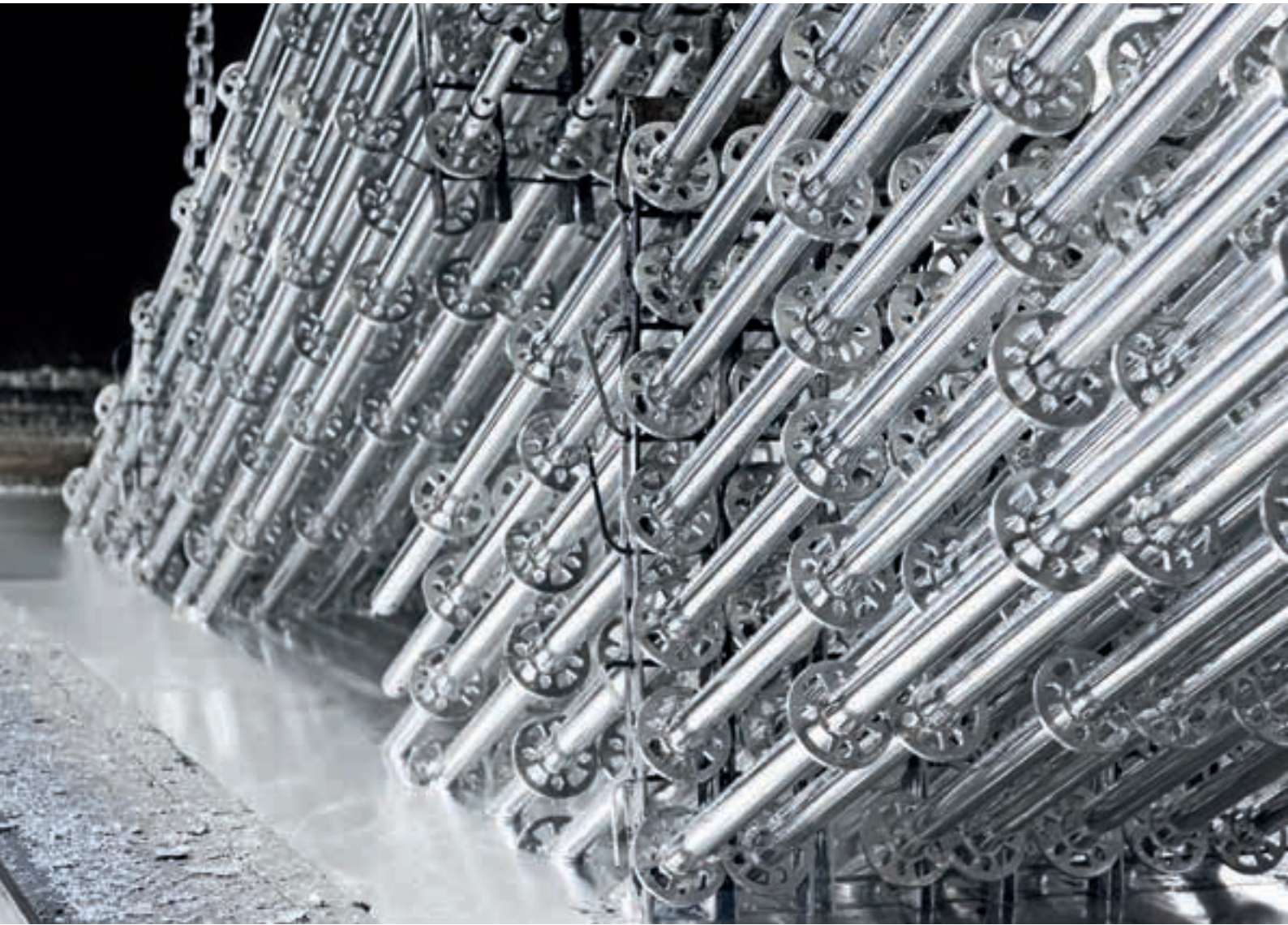

**SAFETY MEASURING
21,000 KILOMETRES IN LENGTH.
EACH AND EVERY YEAR.**

**THE LATEST SAFETY STANDARDS AND CERTIFICATIONS:
WITH LAYHER YOU ARE IN VERY SAFE HANDS.**



WE PROCESS APPROXIMATELY 21,000 KILOMETRES OF STEEL TUBING EACH AND EVERY YEAR.

We assume responsibility for the safety of our customers with every metre of steel tube we make. This is why one of Layher's core tasks is quality management. Our products are compliant with the very latest safety standards and possess DIN/ISO certification, German TÜV approvals plus many other German and international seals for excellent quality. We have been DIN EN ISO 9001-certified since 1994.

GERMANY'S LARGEST HOT-DIP GALVANIZING FACILITY

The two fully automated and ultra-modern galvanizing facilities have a capacity of 170,000 t/year. They are certified for compliance with DAST Directive 022 and meet the latest environmental regulations and requirements.

UNCOMPROMISING QUALITY

Our uncompromising commitment to quality is comprehensive – despite our suppliers being certified – commencing with thorough inspection of incoming goods, and impacting all areas of production.

Moreover, we do not outsource any process which we regard as being a core competency. We also believe in people power – so we rely on employees who have years of experience behind them, and continually invest in skills development programmes.



Quality management is not just about rigorous checks at each stage of production: identification and documentation of all components is also important. At the end of its production process, therefore, every Layher component is stamped with information on the machine used, the date of manufacture and its various production parameters.

MORE SPEED: LOGISTICS AND AVAILABILITY.



Layher is able to draw on scalable production resources and significant inventories, and can therefore guarantee customers extremely rapid and reliable delivery. No matter what the quantity required, we can supply the right product at the right time – to anywhere in the world, via subsidiaries in all five continents and a network of service centres. Our logistics processes are designed around the understanding that our customers have no time to lose: they can collect the materials they require from their nearest Layher service centre, have it shipped to their warehouse, or delivered just-in-time to the construction site. As a result, they can commence work without delay, and complete their projects to tight deadlines, without compromising on quality.



MORE EXPERIENCE: ON-SITE, HANDS-ON ADVICE.



Our success is based on our customers' success. Which is why we believe in close collaboration, and on genuine, lasting partnerships. Layher engineers and other specialists get to grips with the specific challenges and imperatives of our customers, developing solutions that deliver the right results at the right price. Starting from person-to-person consultation at the site by Layher sales engineers to project planning and support by our project engineers, to advice on applications and sites.

Here too Layher provides advice and support. With existing customers, it might be a case of trying a different approach. With new customers, it might be support with the first-ever deployment of Layher scaffolding. Our expertise is available anywhere in the world – for a large-scale project, or for a highly specific aspect of particular application.



MORE KNOWLEDGE: THEORETICAL AND PRACTICAL TRAINING.



Further training as the key to success: in toughly contested markets, companies need qualified employees. For this reason, Layher organises regular theoretical and practical seminars to prepare customers for current and future challenges in scaffolding, and to show them how to make the most of Layher products – for greater safety and expertise.

We supplement our seminars by many further offerings, such as practical product training and round-table meetings with presentations by industry specialists and group discussions amongst scaffolding professionals. Finally, our comprehensive technical documentation is always popular, ranging from instructions for assembly and use to handy tips and in-depth technical brochures.



MORE VISIBILITY: SOFTWARE AND LOGISTICS SUPPORT.



The Layher LayPLAN planning solution and Layher tools for AutoCAD® enable customers to save time, make the best possible use of available resources, and to streamline their logistics. Layher software means greater reliability when it comes to budgeting and project planning, improved inventory management, and complete cost transparency.

With both SpeedyScaf and Allround Scaffolding: the user simply enters the dimensions and the required scaffolding structure, and within a matter of moments the Layher software creates a scaffolding proposal, with material list and assembly sketch for the area to be enclosed, including total price and total weight – available as a printout. There is no faster, more cost-effective or reliable way to plan scaffolding.

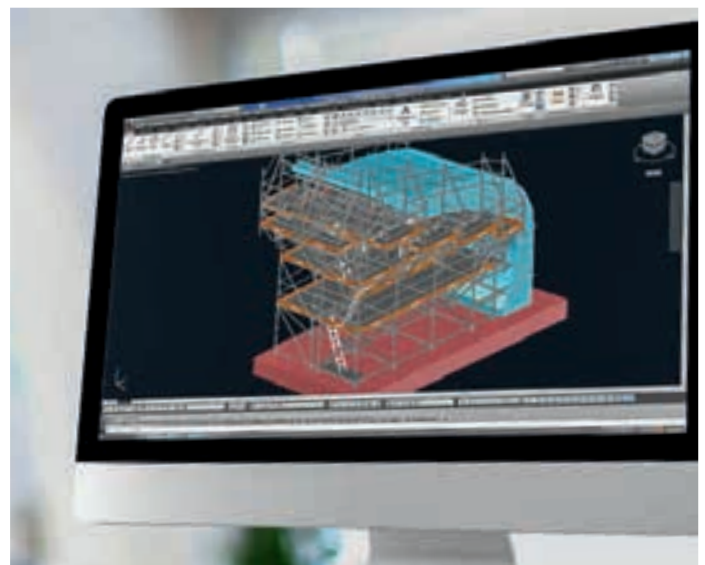

THE VERSATILE SOLUTION: LAYHER ALLROUND SCAFFOLDING®.



THE FLEXIBLE

The proven combination of positive and non-positive connections in rapid bolt-free system technology with AutoLock function permits connections that are automatically right-angled, obtuse-angled and acute-angled as required, with built-in safety at the same time. Layher Allround Scaffolding has become a synonym in the marketplace for modular scaffolding.

This original system has been continually improved since it was launched in 1974, and offers a convincing variety of uses: at every construction site, in industry, chemical plants, power stations, shipyards and for events. As scaffolding for working, protection, facades or for support, as internal or birdcage scaffolding, or as rolling towers.

Even with very difficult layouts and architecture styles and with heightened safety requirements, Allround Scaffolding is always the fast, safe and economical solution.



As work scaffolding and safety scaffolding at the facade, as birdcage, trestle and suspended scaffolding, or as a rolling tower – the right scaffolding at all times and for every job and requirement. For very difficult ground plans and anchoring conditions, for very irregular structures, and for jobs with increased safety requirements.

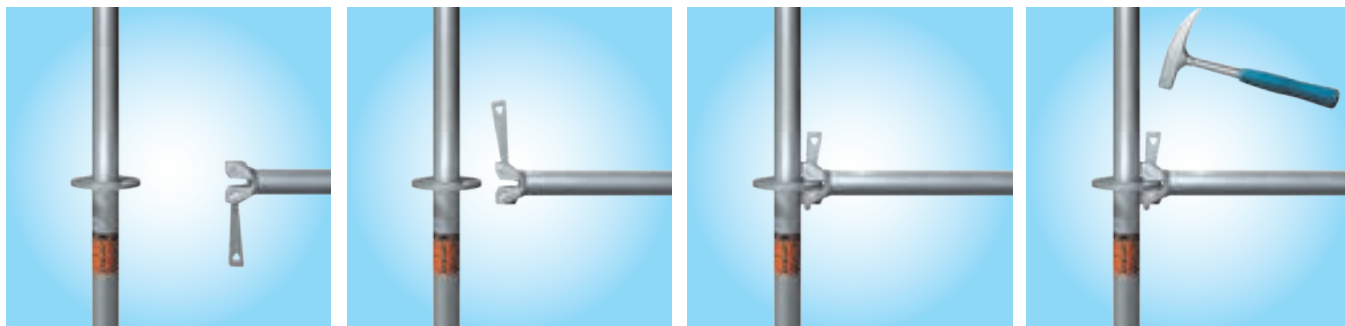

It's this easy: Turning the ledger and slightly tilting it before assembly activates the AutoLock function.

As the wedge-head is pushed over the rosette, the wedge drops automatically into the recess and is **immediately secured against any possibility of shifting or dropping out.**

This means: safe 1-man assembly, whatever the height.

The flat rosette without recesses or bulges prevents it getting clogged with the dirt, whatever the type, that makes assembly difficult.

A hammer blow on the wedge transforms the positive connection into a superbly strong non-positive one.

The wedge-head is precisely matched to the radius of the standard at the front end – so forces are applied to a flat surface and always centrally into the standard.

What's the good of a bolt-free connection if the time you save is lost again by having to measure the right angles?

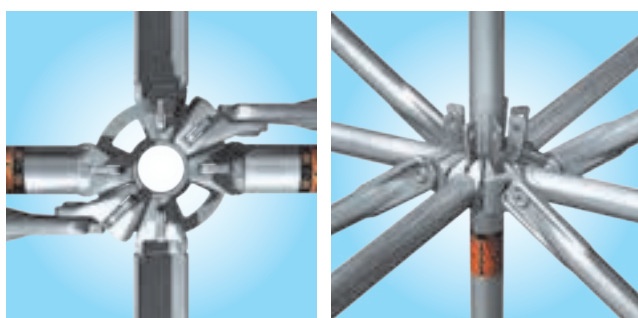
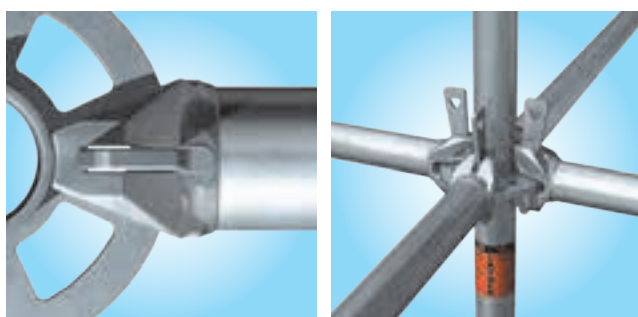

The result of superior engineering: up to 8 connections can be made in the structurally ideal Allround connector on one level and at various angles. How the system is assembled is self-explanatory.

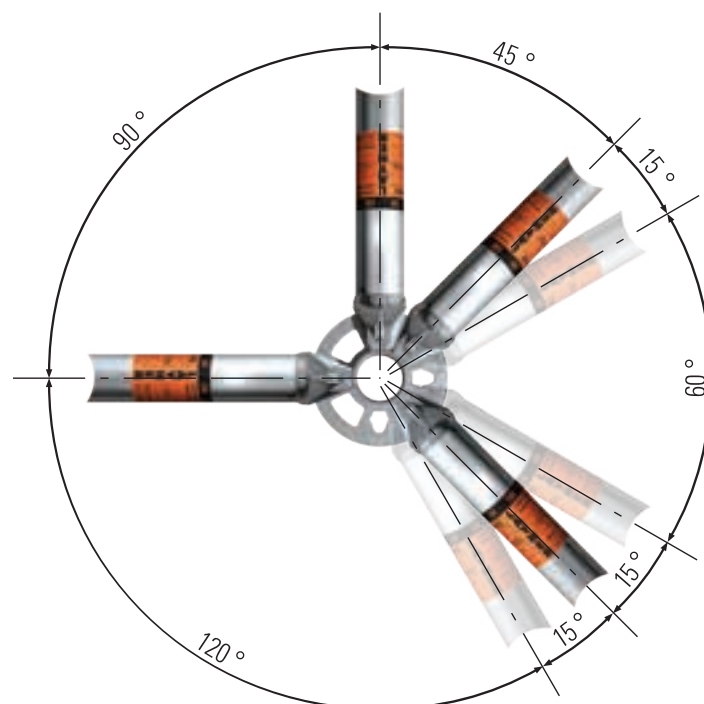

Built-in assembly speed: the 4 narrow openings in the rosette automatically centre the ledgers in the correct dimensions and at right angles – the 4 wide openings permit alignment of ledgers and diagonal braces at the angles required.

General building authority approval:

Z-8.22-64, Allround Scaffolding Steel, with connector approval and standard version ad work and protection scaffolding at the facade. The following further approvals have also been granted: Z-8.22-939, Allround Scaffolding Lightweight components and their combination with one another in Z-8.22-949 and Z-8.22-64.1 Allround Scaffolding Aluminium.

THE FAST SOLUTION: LAYHER SPEEDYSCAF®.



EASY AND FAST

For decades now, Layher SpeedyScaf equipment has been the recognized leader in insertion-frame systems with the SpeedyScaf assembly frame Lightweight. It is a solution that is robust, strong, and extremely fast, making it ideal for work on building facades. Layher SpeedyScaf is, thanks to its versatile and well thought-out range of parts, equally economical to use in scaffolding construction and in professional trades.

With just six basic elements and a few manual operations, this logically and safely erected scaffolding is "speedy" because it is assembled without bolts. Numerous expansion parts permit optimum adaptation to existing building geometries – without much extra effort during assembly. SpeedyScaf is available in different scaffolding widths, made of hot-dip galvanized steel or lightweight aluminium, for every application.



The sum of all advantages cleverly combined: that's the secret behind the success of Layher SpeedyScaf – and hence the secret behind the success of every single user – every single day.



Simple technology with a convincing mix of perfected and detailed solutions:

- ▶ uncomplicated insertion system for fast and effortless assembly,
- ▶ few basic elements,
- ▶ logical expansion possibilities and rapid extendability,
- ▶ complete safety even during assembly,
- ▶ ergonomically advantageous and easy to handle,
- ▶ minimal care expenditure.

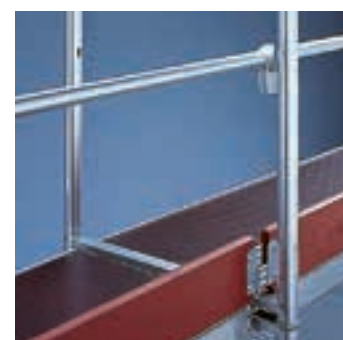
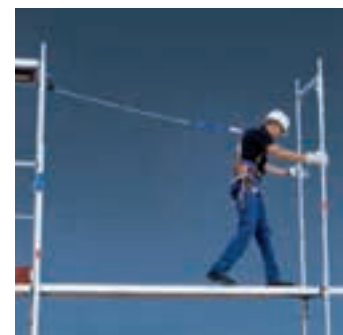

General building authority approval:

Z-8.1-16.2, SpeedyScaf 70 Steel with 10 standard versions having platform heights of up to 80 m. Structural calculations are available for other special extension versions.

The following further approvals have also been granted: Z-8.1-844, SpeedyScaf 70 Aluminium and Z-8.1-840 SpeedyScaf 100 Steel.

PROTECT SYSTEM.



The Layher Protect system delivers across the board in terms of eco-friendliness, noise control, safety for passers-by and protection against the elements – while offering an attractive look-and-feel.

The dust-free design is ideal for asbestos removal, for facade work and sand-blasting. Moreover, its exceptional acoustic insulation properties mean the system is also suitable for temporary noise control, e.g. construction sites in urban areas or at major events.

- ▶ High-performance solution geared to stringent environmental protection legislation
- ▶ Modular design, compatible with SpeedyScaf and Allround Scaffolding
- ▶ Highly durable, no need for disposal of sheeting, extremely cost-effective
- ▶ Highly precise dimensions, low weight, ease of use



KEDER AND CASSETTE ROOFS.



Layher cassette roofs have proven an enduring hit for conversion work, for adding additional storeys, for renovation and restoration. Throughout the project, the building itself and interior fittings and furnishings enjoy robust protection, and business operations can continue unaffected thanks to an effective roof covering. For small and mid-length roof spans, Layher Keder Roofs are the perfect one-stop solution – light in weight, and attractive in appearance.

- ▶ System-independent, proven technology for protection against the weather
- ▶ Suitable for large roof spans
- ▶ Rapid assembly, highly versatile
- ▶ Robust and highly durable



STAGES AND STANDS.



Layher Stages and grandstands deliver outstanding performance – for festivals, rock concerts, sports events and open-air theatre. With their modular design and easy-to-use individual components, it is possible to create remarkable structures both indoors and out.

The Layher Event system is based on extremely robust and strong All-round Scaffolding. High-volume production and rapid time-to-delivery help lower costs, contributing to the commercial success of the event.

- ▶ Rapid assembly, outstanding flexibility and safety
- ▶ Low weight and extremely compact – ideal for shipment
- ▶ Available in steel and aluminium
- ▶ Over 30 years' experience in designing structures for events



ROLLING TOWERS AND LADDERS.



High-quality materials, very safe design and production to stringent specifications: Layher rolling towers and stairway towers are an essential tool for craftsmen, construction industry and public area constructions. These products offer a variety of possibilities and outstanding maneuverability. Stairway towers for a broad spectrum of application and requirements round off the range of access solutions.

- ▶ The Layher modular system can be flexibly adapted to every kind of requirement
- ▶ Quick and easy assembly thanks to easy-to-use components
- ▶ Exceptional stability allows to focus on the essentials
- ▶ Extremely safe design, in accordance with the very latest standards



FOR OUR CUSTOMERS, WE GO BEYOND THE LIMITS. AND WE GO BEYOND FRONTIERS.

LAYHER KEEPS CLOSE TO ITS CUSTOMERS, IN TERMS OF SERVICE AND IN TERMS OF GEOGRAPHICAL PROXIMITY. WHEREVER OUR CUSTOMERS NEED US, WE WILL BE THERE – WITH OUR ADVICE, ASSISTANCE AND SOLUTIONS.

Proximity to the customer is highly valued by Layher. Not only where German is spoken, but all over the world. At the more than 30 service centres in **Germany, Austria and Switzerland** there are extensive material warehouses available, so that you can always get the material you need at short notice.



THE PERSON FOR YOU TO CONTACT

On the Layher website you will find the person you can contact directly, at the plant or out in the field, at: **contact.**

[layher.com](https://www.layher.com)

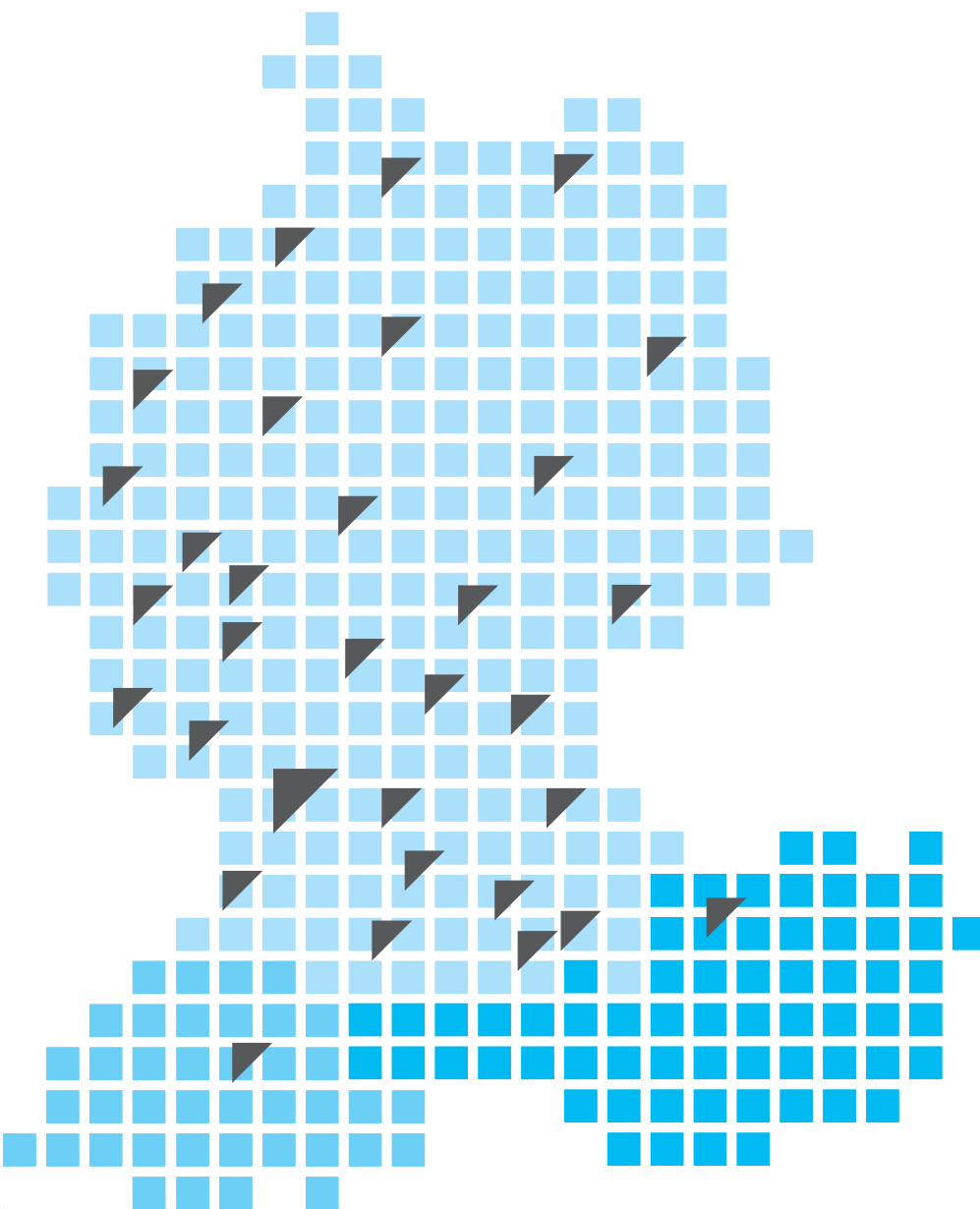

WITH SUBSIDIARIES AND SERVICE CENTRES AT MORE THAN 140 GLOBAL LOCATIONS, WE ARE THERE FOR YOU WITH OUR SCAFFOLDING MATERIALS AND EXPERTISE WHEREVER YOU NEED THEM – AND WITH THE USUAL HIGH LAYHER STANDARDS.

A worldwide network of subsidiary companies ensures that we are always close to our customers. Rely on our Layher standards anywhere in the world: Local warehouses, technical support, training in accordance with national regulations and safety standards.

We are therefore well equipped to deliver the right solutions, with the right people, in the right place. Our customers benefit from the continuous and strategic expansion of the Layher network. Your benefits: Since we know the local conditions, cultural characteristics and of course

each country's specific regulations, we can respond optimally to market-specific needs. This makes us competent partners, especially for internationally operating companies.

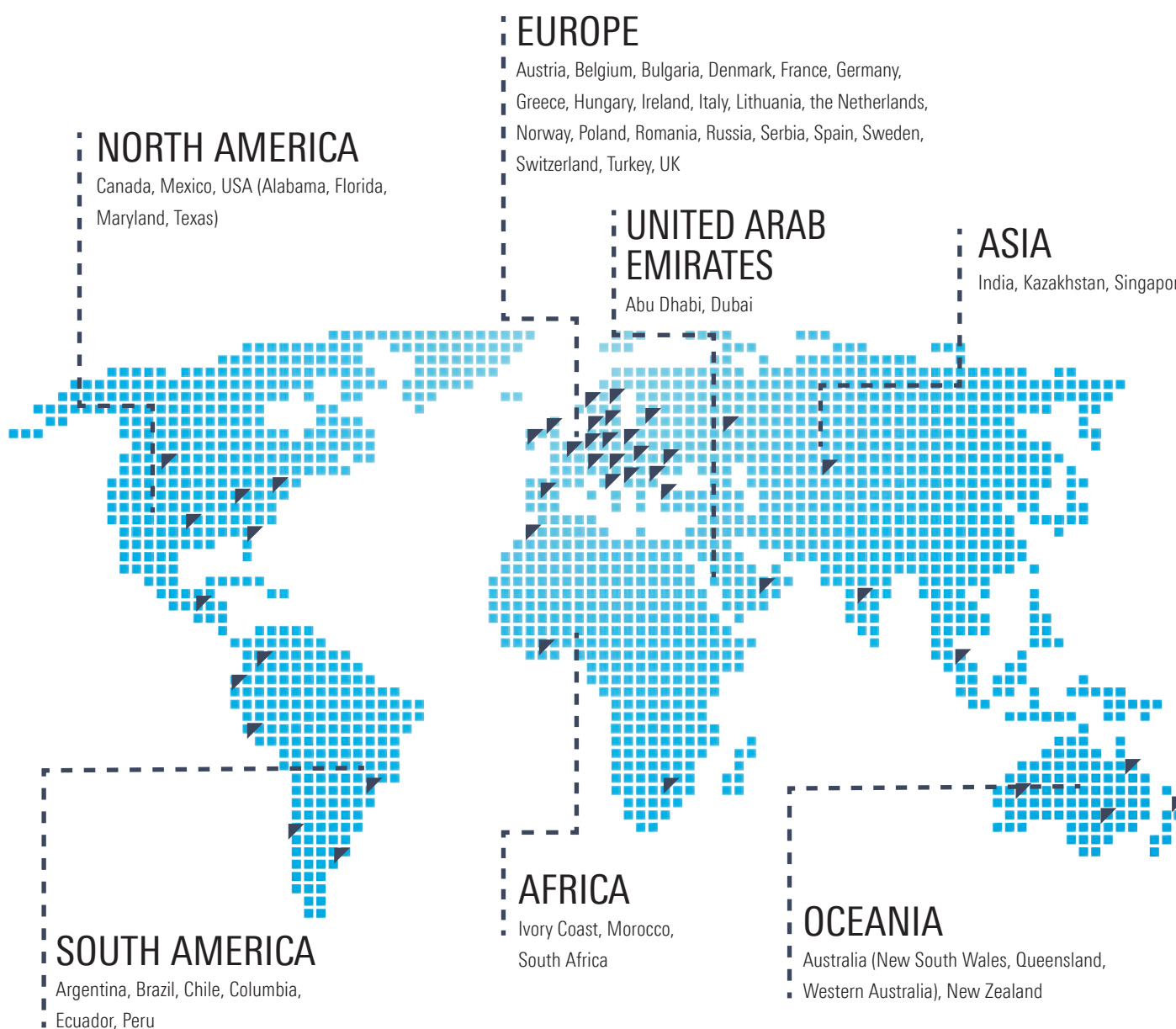



CONSTRUCTION ABOVE GROUND

STAIRWAYS AND BRIDGES

High-level construction sites, escape stairway towers or temporary stairway systems in unfinished buildings. With Layher scaffolding systems, all kind of accesses can be provided inside the system. No more makeshift or ad-hoc solutions, and no heavy special structures made of steel. Modular design permits expansion at any time.

Page
26

REINFORCING, CONCRETING AND FACADE SCAFFOLDING

Access to wall formwork and fitting of steel reinforcements using reinforcing scaffolding with supporting bays and without wall ties. Tension-proof standard joints permit crane positioning of the scaffolding right where it is needed. Bracket-mounted walkways on semi-finished walls can be fitted without any problems thanks to the cavity wall bracket adapter. What's more, a wide range of solutions are available for final plastering or covering of the facades.

Page
30

SHORING FOR CEILING FORMWORK

Absorbing of heavy loads during concreting work for ceilings of all types is made easy with Shoring TG 60. Flexible bay lengths in the modular Allround Scaffolding permit a perfect match with all local conditions. Combinations of shoring and work scaffolding are possible without any problems.

Page
34

NOISE, DUST AND WEATHER PROTECTION (WINTERTIME CONSTRUCTION)

Working regardless of the weather, or the protection of passers-by from a wide range of activities is made possible by Layher's protective systems. Temporary weather protection roofs – which can also be moved to ensure that as little material as possible is used – permit construction work in any weather and in any season. The Protect System, a dust-proof enclosure system, allows work scaffolding to be enclosed, dust and noise protection walls to be put up, or a construction site to be closed off from the outside.

Page
42

ACCESSORIES AND LOGISTICS

Work on flat roofs requires special fall prevention equipment, which the Layher range includes as standard parts. Logistic solutions for economical storage and rapid transport to the place of use, such as system pallets, crane eyelets or material hoists round off the Layher product range.

Page
46

STAIRWAYS AND BRIDGES

Accesses to high-level workplaces or to excavations. The Layher range has the right stairway for every purpose.



PLATFORM STAIRWAY TOWER

With the platform stairway, it is simple to construct a 4-standard stairway tower, either integrated into the work / protective scaffolding or shoring, or as a free-standing access structure anchored on the building. Both parallel and alternating stairways are possible here.

As an alternative to the platform stairway, the tower can also be built with the comfort stairway. This ensures additional safety thanks to its wider steps, and a more agreeable feeling during ascent – particularly for great heights.

Platform stairway: Stairway class A as per DIN EN 12811-1

Comfort stairway: Stairway class B as per DIN EN 12811-1

Permissible load capacity of platform stairway towers: 2.0 kN/m²



MORE SOLUTIONS

The platform stairway tower is also available in modular design. More information on **page 66**.

CONSTRUCTION STAIRWAY TOWER 200

With the Allround construction stairway tower 200, each stairway is assembled from 2 separate U-stairway stringers 200, with standard decks used as steps. On the one hand this reduces the weight / volume of the individual parts, and on the other hand even more stairway width variants are possible. Ideal for use as a convenient access to high-level workplaces, as an escape route and for access to containers.

Stairway stringer 200, 10 steps, L = 2.57 m, H = 2.00 m:

Permissible load 2.0 kN/m² with a stair flight width of 1.29 m.

Stairway dimensions: Riser s = 20 cm

Step width 32 cm (tread a = 24 cm; undercut u = 8 cm)





UNFINISHED-BUILDING STAIRWAY TOWER

The Layher Allround unfinished-building stairway tower fits into many stairway recesses in buildings to house one or more families. It puts an end to improvised and dangerous stairway or ladder solutions inside an unfinished building: thanks to short assembly times with prefabricated and lightweight individual parts, and to its variability with regard to the levels for entries and exits in 25 cm steps. Bracket attachments furthermore allow it to be used as work scaffolding for work on the stairway well walls. By using adapter plates, the screed can be laid without any problem and without dismantling the unfinished-building stairway tower.

Surface area without brackets:

1.57 x 1.40 m (axis dimension)

1.70 x 1.53 m (external dimension)

Exit clearances: 2.50 or 2.75 or 3.00 m

Permissible load capacity: 2.5 kN / m²

STAIRWAY TOWER 750

The stairway tower 750 with child-safety guardrail is intended, in view of its riser dimensions, for both temporary and permanent stairway structures in public areas. Typical applications are as road-crossings during building work, as stairways inside buildings for the duration of the construction work, as a mandatory escape stairway tower or as a construction stairway tower. For the events field, the stairway tower 750 has a high load-bearing capacity, allowing it to be used for accessing stands and stages. Lockable enclosure variants round off the product range for public stairway accesses.

Stairway stringer 750, 8 steps, L = 2.57 m, H = 1.50 m:

Permissible load 7.5 kN / m² with a stair flight width of 2.07 m.

Stairway dimensions: Riser s = 16.7 cm

Step width 32 cm (tread a = 31 cm; undercut u = 1 cm)

A height adjustment outside the 1.50 m standard height dimension is achieved with 5 or 2-step stairway stringers. 8 decks per stair flight.



MORE SOLUTIONS

For further interesting solutions relating to stairway towers please go to **pages 52, 66 and 85.**



TRENCH BRIDGES

Assembled on one side and swung into place by a crane, they quickly create temporary links. For access to the unfinished building above the excavation or as an emergency bridge over streams and rivers, only standard Allround parts and steel decks are needed. You can determine the span using the bay length and the number of bays.

Standard versions for load class 3 (2.00 kN/m²) with optional 3-part side protection.

In certain conditions the free cantilevered method can be used for assembly.

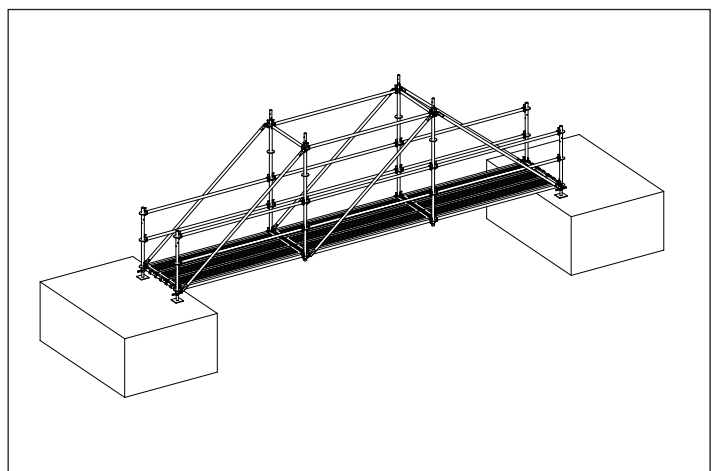



TEMPORARY BRIDGES – BRIDGING LARGE SPANS

Large spans of up to about 30 m can be bridged using the Allround bridging system. This modular lattice system is fully combinable with Layher Allround Scaffolding thanks to the attached wedge-heads. With just a few additional parts, the load-bearing capacity of the proven Allround system can be increased, for example to build wide-span footbridges or bracing structures for heavy loads.

The design permits problem-free and safe pre-assembly on the ground and then lifting of the assembled bridge into place using a crane. Live loads of 5.00 kN/m^2 or 7.50 kN/m^2 for use in areas open to the public. Besides its classic use as a pedestrian bridge, it can also be used without any problem to bridge gaps in facade scaffolding, to strengthen birdcage scaffolding or to strengthen roofs. The lattice beam of modular design can be easily integrated into existing structures, removing the need for complicated and expensive special solutions made of steel for specific projects.

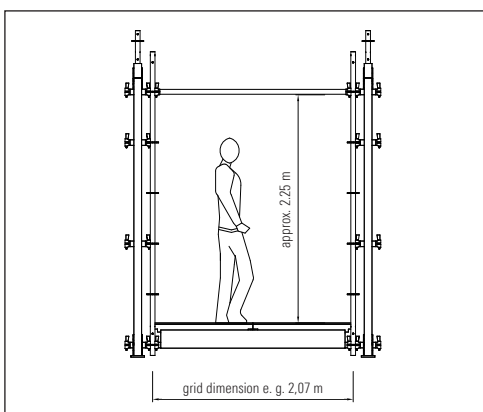

REINFORCING, CONCRETING AND FACADE SCAFFOLDING



REINFORCING SCAFFOLDING

Unhindered access to the wall and beam reinforcements is possible without anchoring. Stability is assured by simple bracing and where necessary also by widening the base. Standard version with strong hot-dip galvanized steel decks. With the right bay lengths you can ensure access to all relevant components, while inside guardrails and brackets provide safety even at some distance from the wall. The scaffolding width can be adapted to the space required. Attachment of the advance guardrail system on both sides of the scaffolding ensures a high degree of safety during assembly itself. It can be moved by crane at any time thanks to tension-proof pinning of the standard joints.

Widths: 0.73 m, 1.09 m or 1.40 m (optionally also with stairway).

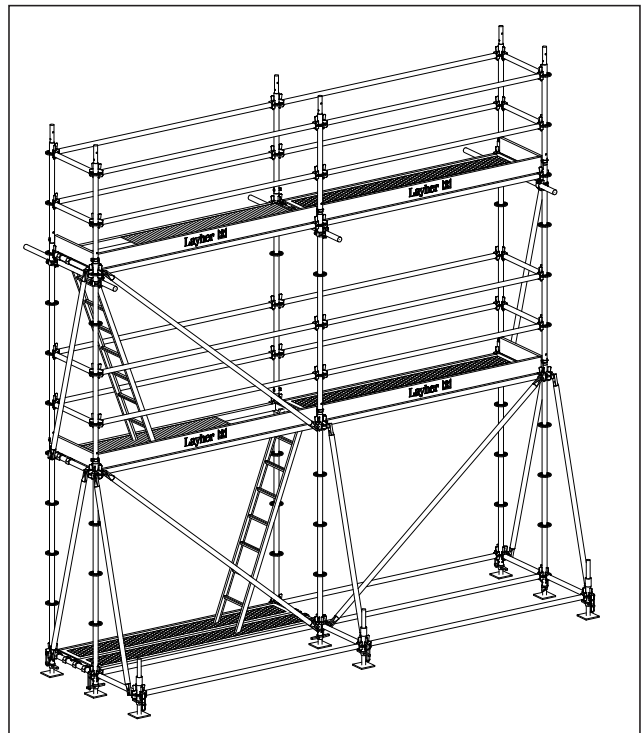

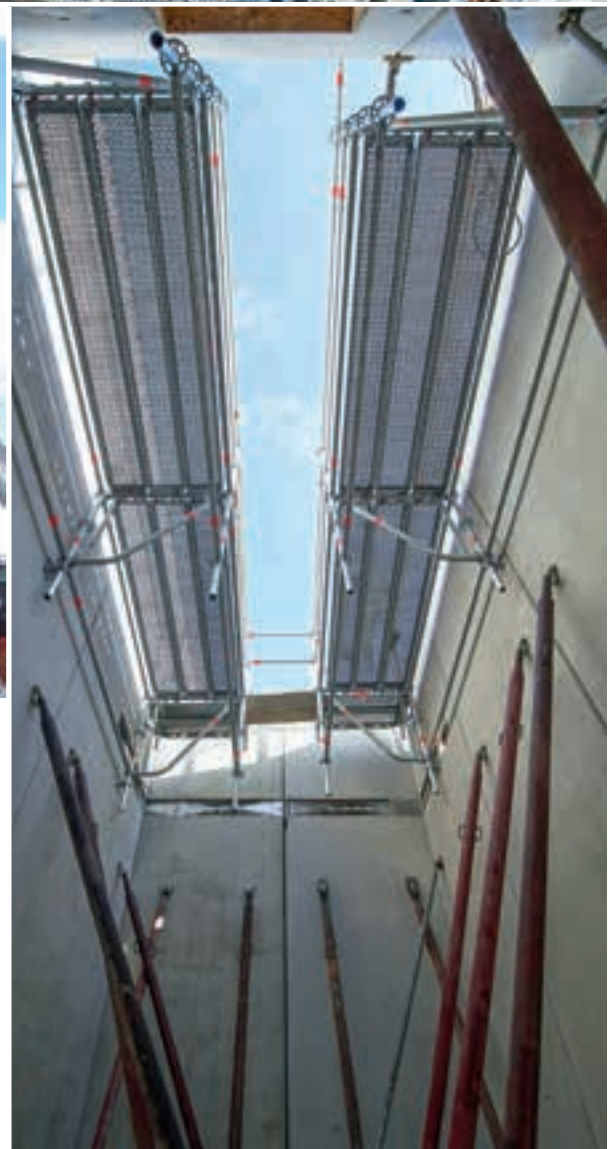

CONCRETING SCAFFOLDING WITH CAVITY WALL BRACKETS

Concreting work on cavity walls requires access to the walls from above. Due to the push-pull props needed, it is often not feasible to work here with conventional standard scaffolding. Thanks to the cavity wall bracket adapter, bracket-mounted walkways made of standard Allround material can be constructed. Variably adaptable in height and bay length, so that the space needed for the angled props can be kept clear.

Non-slip steel decks, a 3-part side protection (also possible all round facing the wall) and very fast assembly thanks to the proven Allround wedge-head technology are also standard features.



FACADE SCAFFOLDING USING ALLROUND SCAFFOLDING®

With its convincing adaptability, Allround Scaffolding is the perfect choice for **very irregular structures**. Particularly in the case of **projections, recesses, and niches**, the advantages of Allround Scaffolding come to the fore.

All work can be performed very efficiently using Allround Scaffolding. As a work and protection scaffolding for bricklayers, concrete workers, carpenters, plumbers, roofers, plasterers and painters, Allround Scaffolding caters for many different requirements all at once.

Allround Scaffolding has received building authority approval from DIBt (German Civil Engineering Institute) as facade scaffolding under Z-8.22-64 and Z-8.22-939. If there is any divergence from the standard assembly, structural verifications are available very quickly – so no delays in assembly.

For great facade heights, integrated stairways access is particularly suitable for non-fatiguing ascent and easier transport of materials and tools.



MORE SOLUTIONS

For more information about Layher Allround Scaffolding see **page 16**.



FACADE SCAFFOLDING FROM SPEEDYSCAF®

With just a few basic elements and just as few manual operations, this classic Layher equipment "speedily" provides a secure base for all work on facades.

A wide and well thought-out range of parts makes countless applications and expansions possible. Like Allround Scaffolding, SpeedyScaf can be equipped with integrated stairway towers for easier upward transportation of materials and tools. Use of Layher SpeedyScaf is particularly recommended for **length-oriented facade scaffolding**.

SpeedyScaf has received building authority approval from DIBt as facade scaffolding, under the numbers:

Z-8.1-16.2 (System 70 Steel)

Z-8.1-840 (System 100 Steel)

Z-8.1-844 (System 70 Aluminium)



MORE SOLUTIONS

For more information about Layher SpeedyScaf see **page 18**.

SHORING FOR CEILING FORMWORK

ALLROUND SHORING TG 60

Together with Layher Allround equipment, the TG 60 shoring frames create even more possibilities. With TG 60, shoring can be built 30% faster, higher, stronger and safer. The TG 60 shoring frames, available in three sizes, are made of steel tubing of extra strength and provided with Allround rosettes. The TG 60 frames are an integral part of Allround Scaffolding and can be integrated without any problems into any birdcage scaffolding.

Each standard of a TG 60 shoring tower can be subjected to a load of up to 6 tons.

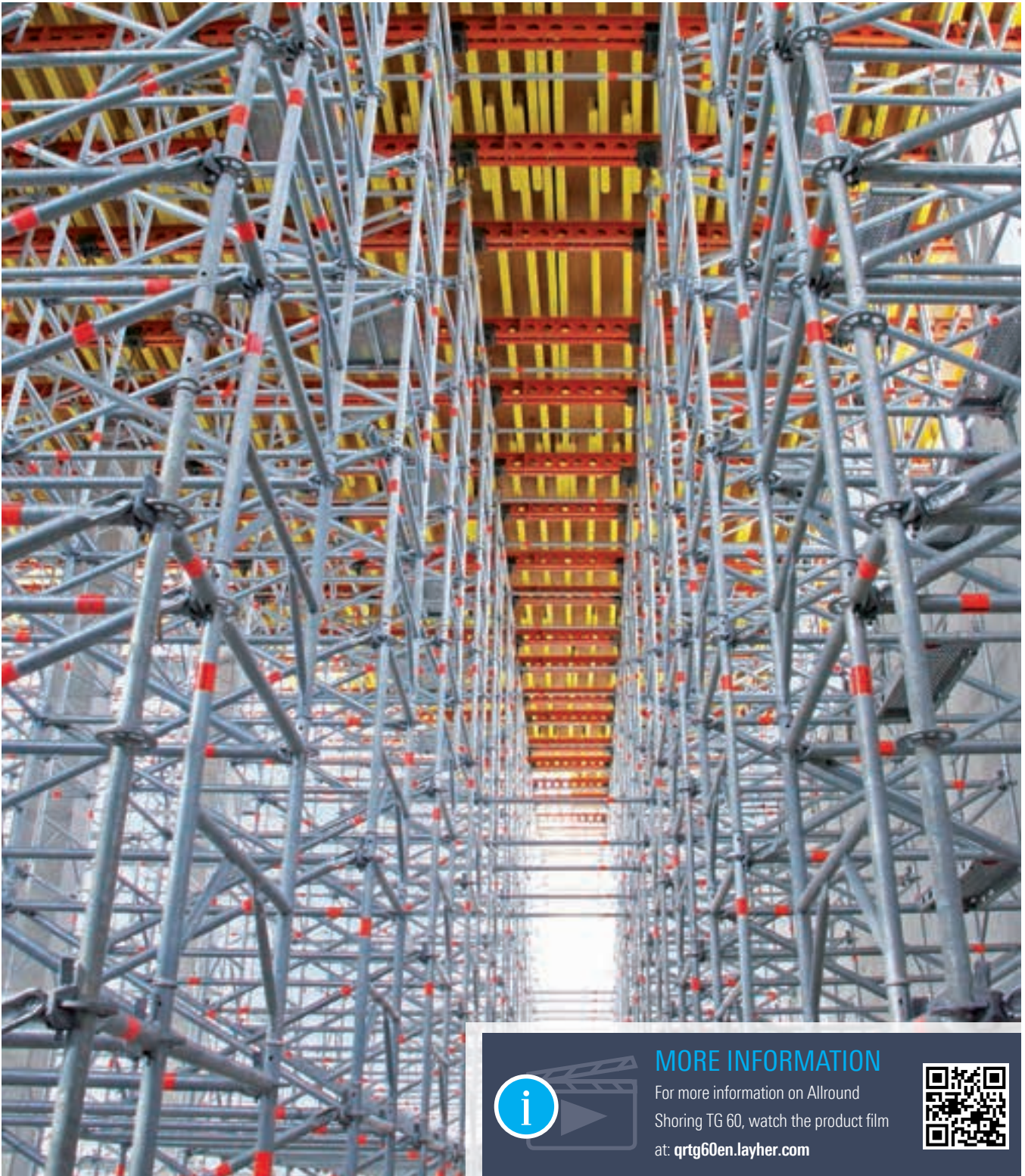

MORE INFORMATION

For more information on Allround Shoring TG 60, watch the product film at: qrtg60en.layher.com



Connecting up the shoring towers TG 60 using Allround ledgers makes time-consuming measurement unnecessary. The towers are automatically at right angles to one another, further reducing the risk of tipping over.

The shoring towers TG 60 can be adapted without problems to any specific factors of the structure, terrain or configuration dimension of the formwork supports. The ground plan of the shoring tower TG 60 results from the 1.09 m wide frames and the Allround ledgers used, from 1.09 m to 3.07 m.

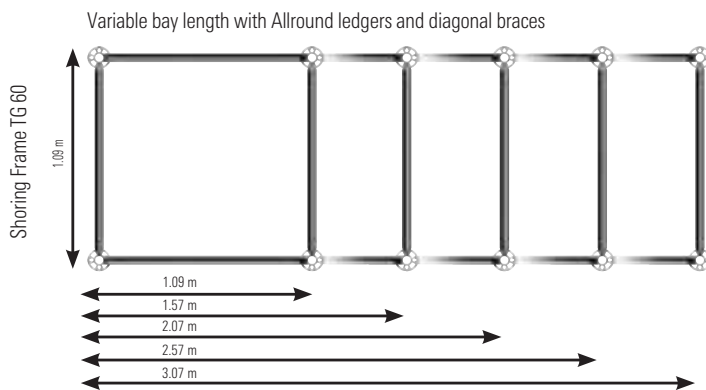

TG 60 shoring towers can be assembled at the site either upright or, thanks to their high fitting precision, lying on the ground, for subsequent crane movement. Fully assembled towers can be moved using easy-to-fit wheels.



The innovative assembly sequence and the integrated access aid make the assembly of a shoring tower safer than ever before. During upright assembly, you are always protected by an automatically integrated side protection – without any further safety equipment.

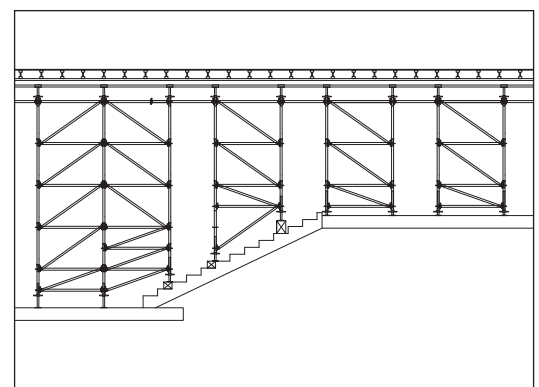
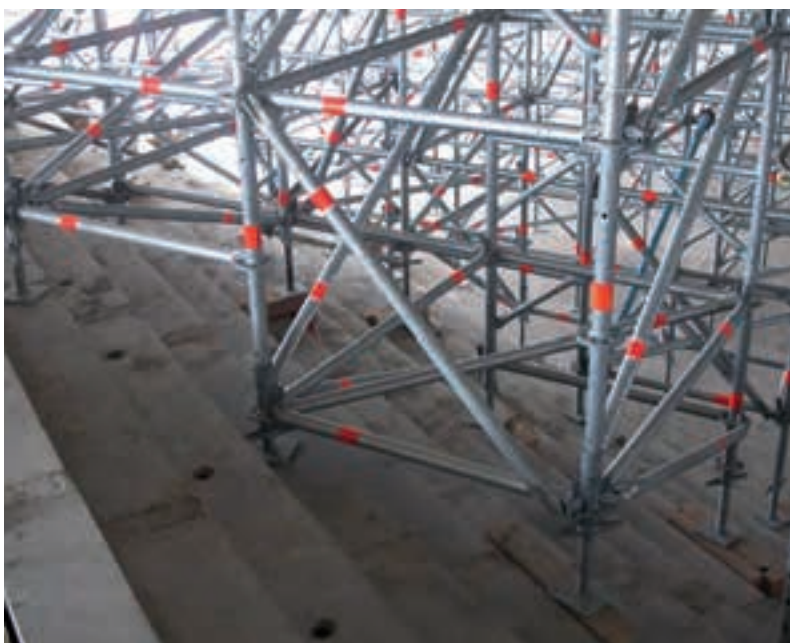

Allround Shoring TG 60 can be adapted without problems to any local conditions. Height adjustment at the top and bottom, and geometry adaptations at the edge, can easily be done using the Allround construction kit.



Allround Shoring TG 60 permits the laying of a deck level for safer work on the ceiling formwork. A gap-free and non-slip work surface is assured by perforated steel decks with maximum load capacity.

It is also easy to integrate accesses in the form of access bays or platform stairways into the shoring. Combination of shoring and work scaffolding with one system. This allows all the current safety-related requirements to be implemented quickly and easily.

Shoring with truck access is possible even without the use of bridging structures with heavy steel beams. Simple lattice structures can bridge the usual access widths of around 4 – 5 m.

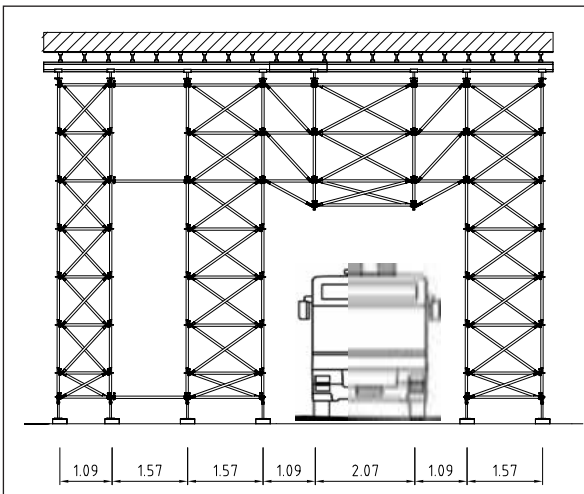

For very heavy loads, the shoring towers can be reinforced by additional frames. Combining frames allows the load capacity to be increased to almost any level. The picture shows shoring for absorbing a line load of 250 kN / m.



MORE SOLUTIONS

For further interesting solutions relating to shoring please go to **pages 54 and 58**.



Concreting of building projections is not problem even at great heights thanks to the modular Allround system. The towers are braced using system components, i.e. without time-consuming constructions made of pipe and couplers. Bracket-mounted walkways with side protection at their edges are quick to assemble.



When the prefabricated ceiling slabs (e.g. for balconies or arcades) are lifted into place, the TG 60 shoring towers ensure the necessary stability instead of single supports. Shoring towers connected to one another are per se non-positively connected, allowing the prefabricated slabs to be shifted into their exact position. Swaying and shaky substructure made from single supports often made this assembly work difficult in the past.



The variable system also permits support in the manufacture of tall and wall-like concrete beams cast in-situ, with semifinished ceiling slabs laid between them. Material optimisation by absorbing the ceiling loads using a latticework of Allround standard components between the shoring towers. No need for additional towers in the intermediate spaces.

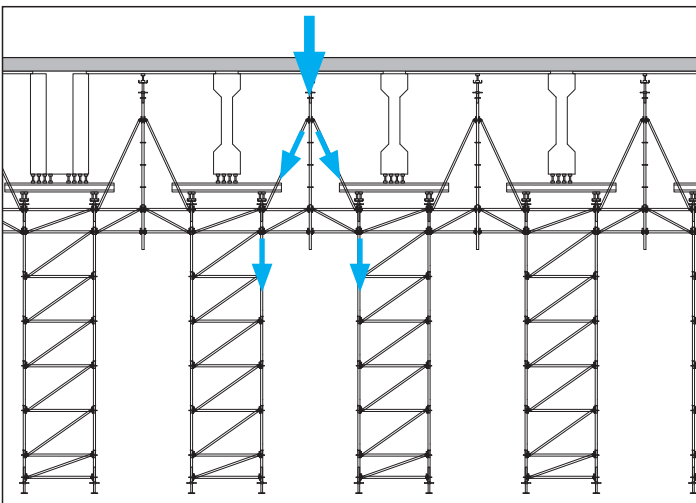



Shoring TG 60 can also be used as a substructure for pre-assembled slab tables. Thanks to a tension-proof connection of the head jacks to the slab tables, the unit can be moved by crane complete and in a time-saving way. With attached wheels, the slabs can be moved horizontally inside a storey level.



Step 2: Concreting the ceiling

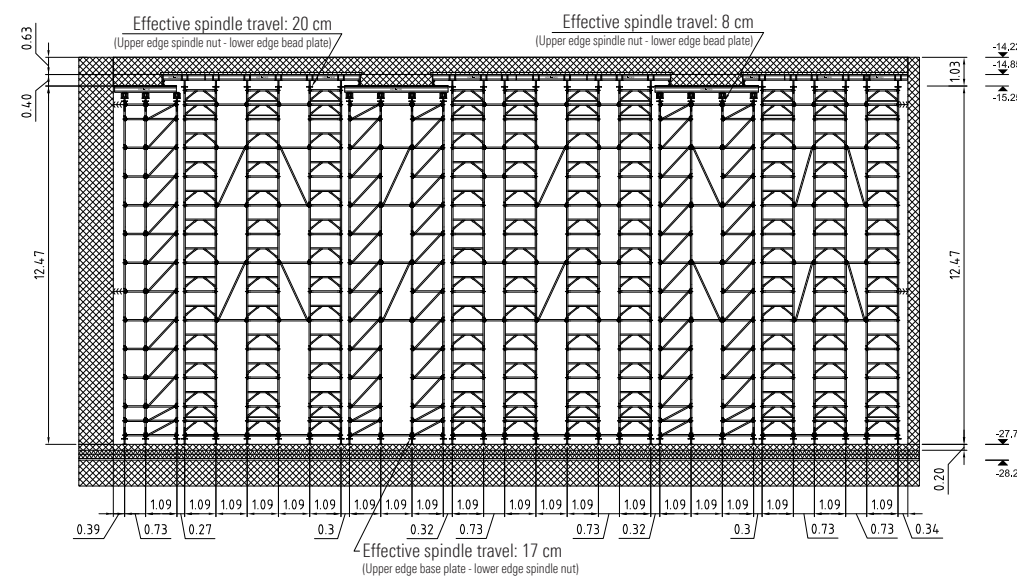

Thanks to the modular and flexible construction kit system of Allround Shoring TG 60, it can be used for several building phases without extensive modification work.

In this example, the binding beams are concreted in a first step, and the ceiling resting on them in a second step. Integrated decks reduce the risk of falls.

Assembly in standard system dimensions using Allround standard parts enables alignments to be perfectly maintained without time-consuming measurement. Absolute fitting precision ensures a smooth implementation of planning work at the construction site.



NOISE, DUST AND WEATHER PROTECTION (WINTERTIME CONSTRUCTION)

PROTECTIVE WALLS AND ENCLOSURES

Noise control, privacy screening or dust protection walls can be built easily, quickly and safely using Allround Scaffolding and the Layher Protect System.



The modular Protect System consists of cassette elements easily fitted to the scaffolding and optionally provided with a galvanized steel sheet or a translucent plastic ribbed panel. An all-round rubber seal ensures a neat and precisely fitting connection to the adjacent elements. The result is a dustproof, weatherproof and noise-reducing partition wall between the site and the environment. Work scaffolding for modernisation or demolition work can be sealed off dust-tight to protect passers-by from dust, noise and pollutants.

Technical data:

Thermal insulation of light cassette: $3.3 \text{ W/m}^2 \text{ K}$

Airborne sound insulation of wall cassette: $R'_w = 26 \text{ dB}$

WEATHER PROTECTION ROOFS

There are a wide range of reasons for using weather protection roofs. Work on buildings, bridges or roads during winter, despite rain and snow. Work on roofs and adding new storeys can be performed while the building is still in use. The different system Layher cassette roof and Layher Keder Roof XL offer the right solution for a wide range of applications. For small, medium or very large spans – even with snow loads. Optional ties and solutions for ridge supports make it possible to increase spans almost indefinitely. The roof systems can be made mobile by Layher, to ensure economical use of materials and to permit supplies to the site by crane.



CASSETTE ROOF

The **Layher cassette roof** has established itself as a firm favourite at construction sites for conversion, added storeys, renovation and restoration. The structure itself and all the equipment is protected during conversion or roof repair work, and normal business operations can continue under a secure roof.

Wide spans, walk-on roof surfaces and the option of opening the roof at any point are further crucial advantages.

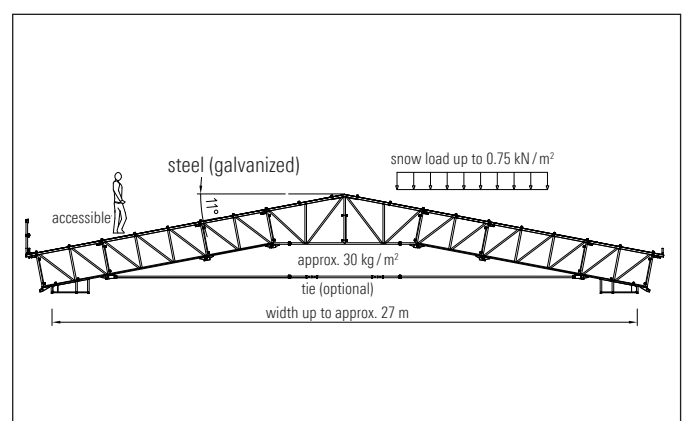



KEDER ROOF XL

The range of the **Keder Roof XL** extends, taking into account local weather conditions, to a roof width of up to 40 m. For low roof widths, assembly can be completely manual. The applications are varied, and range from roofs over work on additional storeys, repairs to timber roof frames, coverings, weather protection for new structures, and modernisation work on motorways and over bridges. In combination with gable and wall tarpaulins, completely closed enclosures can be made. The optimum solution for wintertime construction sites.

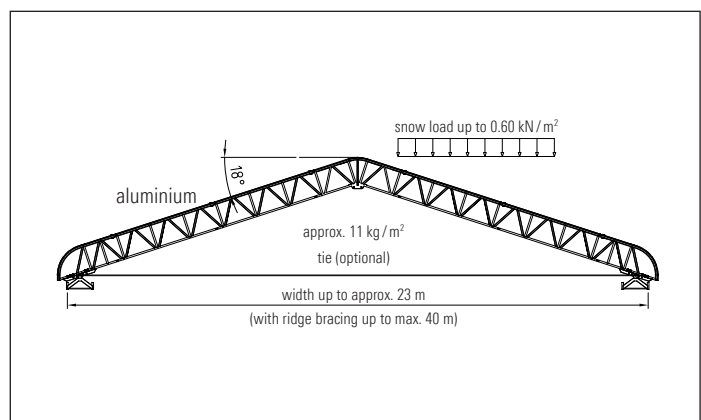

MOBILE ROOFS

Layher's Keder Roof XL can be made mobile using a small number of additional components. That makes this roof system even more economical, when for example only single building phases have to be roofed.

Openings for supply by crane can be created simply by pushing the roof sections apart.

The bay width of the roof can be selected regardless of the bay width of the support scaffolding.

Assembly is made enormously easier, since the roof is assembled bay by bay from gable scaffolding and can be pushed forward. Minor divergences in the parallelism of the two support scaffolding structures are compensated by a transverse trolley movement.

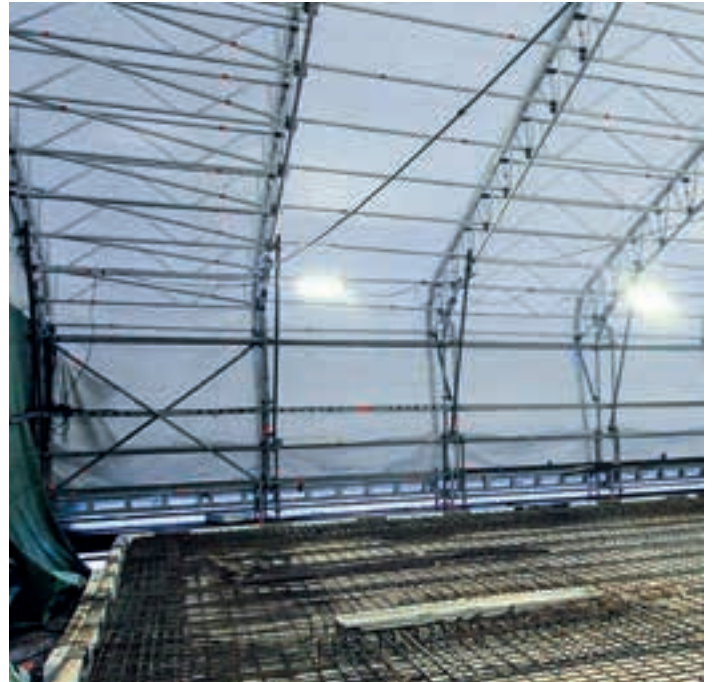

ACCESSORIES AND LOGISTICS



FLAT ROOF GUARDRAILS

The rules of the professional association (BGV) regarding health and safety when working C22 "Construction work" require a fall prevention system at workplaces and walkways on roofs where the fall height is more than 2 m.

The GS-tested flat roof guardrail meets this requirement.

With a few additional components for the Allround system, the flat roof side protection is easy, quick and safe to assemble.

BALUSTRADE CLAMP

The accident prevention regulations of the professional associations are also met with the Layher balustrade clamp. It can be used for concrete floors and fascias of 16 to 33 cm height and for flat roofs. The guardrail is constructed with Allround Scaffolding or SpeedyScaf guardrails.



PALLETS

Layher also thought about storage and safer transportation, because sound logistics are essential for successful work at the site. For some system components, special system pallets are available. They are designed for space-saving storage, movement by crane or fork-lift truck, stackability and long life.

For all other components, an extensive range of non-system pallets and skeleton boxes is available: sturdily made of steel and corrosion-resistant thanks to hot-dip galvanizing.

This ensures that in a very short time you can get the right material to the right place, exactly as you need it.



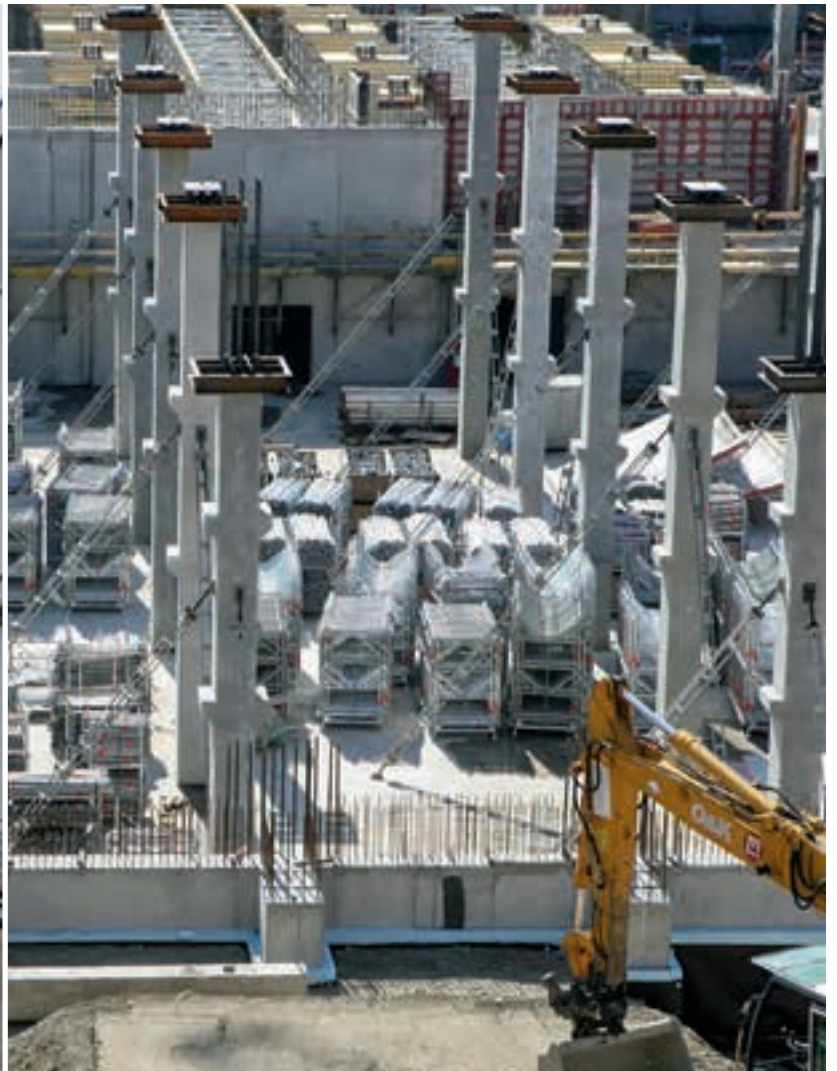



CONSTRUCTION, BELOW GROUND

TUNNEL SCAFFOLDING AND TUNNEL TRUCKS

Reinforcement work and subsequent work on tunnel ceilings is performed by tunnel trucks constructed using Allround Scaffolding. Mounted on rails, they ensure maximum efficiency, with only a small building section having to be provided with scaffolding, which is then moved to keep pace with the work.



Page
50

STAIRWAY TOWERS – FREE-STANDING AND SUSPENDED

Accesses to shafts can be created using Layher's extensive stairway range. It doesn't matter if it's free-standing and suspended – for every requirement the right solution is available.



Page
52

SHORING

Absorbing heavy loads is made easy with Shoring TG 60 and the Allround heavy-duty support. Particularly heavy loads can be handled by combining standards or frames. Flexible bay lengths make it possible to use material efficiently. Modular Allround Scaffolding permits a perfect match with all local conditions. Accesses for trucks can be provided without any problem.



Page
54

TUNNEL SCAFFOLDING AND TUNNEL TRUCKS



TUNNEL TRUCKS FOR REINFORCEMENT WORK AND SUBSEQUENT WORK

Work on tunnel ceilings for reinforcement or other treatments require a work platform that adapts to the curving tunnel ceiling. No problem at all with flexible Allround Scaffolding.

Scaffolding that moves to keep pace with the building progress can be a crucial advantage, as it reduces the use of material to what is necessary for structural strength and the design.

Wheels of differing load capacity, up to rail-mounted flanged wheels, ensure a mobile scaffolding structure for a wide range of applications. The scaffolding can be matched to practically any contour, making them usable even in poorly accessible spots.

Pre-assembly of complete scaffolding units and subsequent crane movement to where they are used is possible even with large scaffolding.





STAIRWAY TOWERS – FREE-STANDING AND SUSPENDED



Platform stairway towers can be assembled for access to excavations or shafts in a **free-standing** design. Both unidirectional and material-saving alternating construction with inner guardrails is possible. Available as a scaffolding stairway of Classes A or B as per DIN EN 12811-1, in step widths of 64 cm and 94 cm.



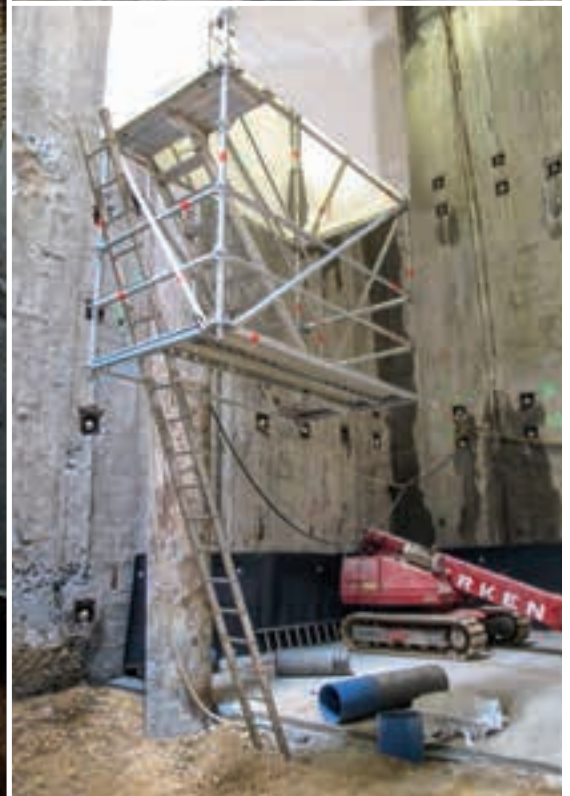
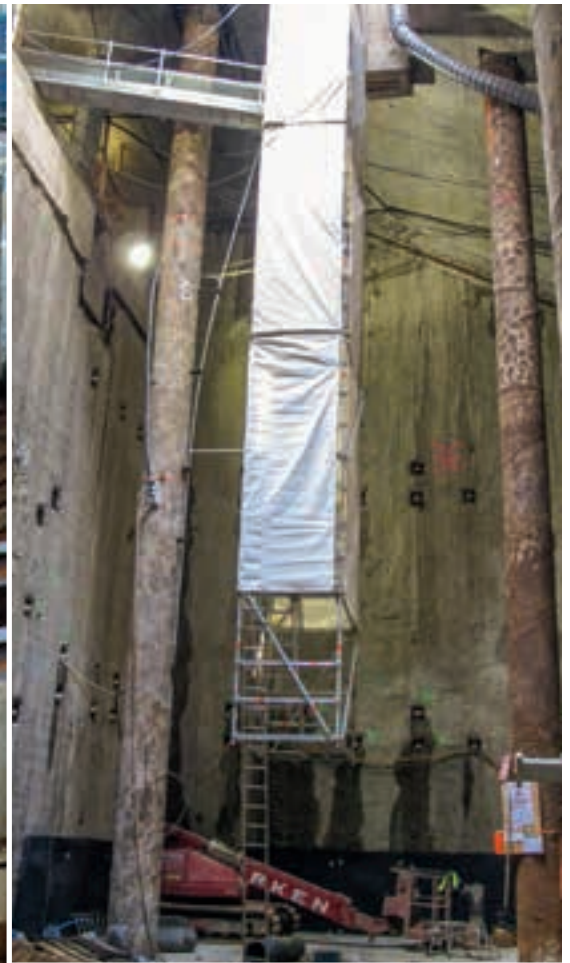

Thanks to tension-proof pinning of the standard joints, platform stairway towers can also be assembled **suspended** from top to bottom. With the new Allround LW standards, this is even possible without special suspended scaffolding standards. An interesting application in underground construction for sites using the cut-and-cover method.



MORE SOLUTIONS

For further interesting solutions relating to stairway towers please go to [pages 26, 66 and 85](#).

SHORING

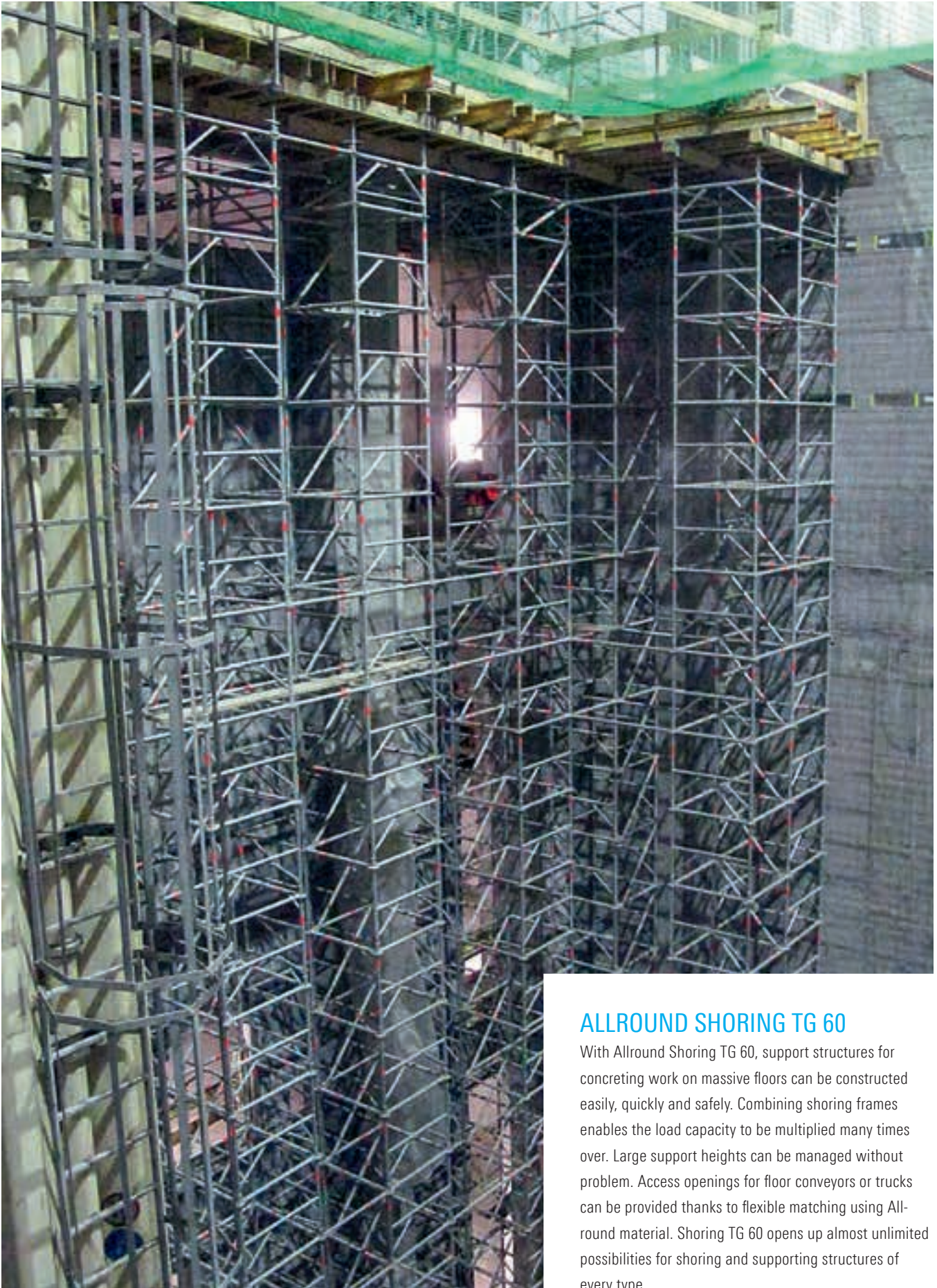

ALLROUND SHORING TG 60

With Allround Shoring TG 60, support structures for concreting work on massive floors can be constructed easily, quickly and safely. Combining shoring frames enables the load capacity to be multiplied many times over. Large support heights can be managed without problem. Access openings for floor conveyors or trucks can be provided thanks to flexible matching using All-round material. Shoring TG 60 opens up almost unlimited possibilities for shoring and supporting structures of every type.



MORE SOLUTIONS

For further interesting solutions relating to shoring please go to **pages 34 and 58.**



BRIDGE CONSTRUCTION

SHORING – TG 60 AND HEAVY-DUTY TOWERS

Large and cohesive shoring structures for absorbing loads when the superstructure is concreted. Ideal adaptation to the terrain and an economical use of material are the main features of Layher Allround Shoring TG 60. With the Allround heavy-duty support, very high point loads can be selectively absorbed.



Page
58

WORK SCAFFOLDING, FREE-STANDING AND SUSPENDED

Access to pillars, bridge caps and as a vantage point can be provided with free-standing or suspended scaffolding. This ensures that every point on the bridge can be reached. For economical scaffolding during modernisation work, the work scaffolding at bridge caps can also be designed mobile.



Page
62

PROTECTIVE ENCLOSURES

For protection from dropped working materials or blasting material during corrosion prevention work on bridges with intersecting roads or rail lines, work scaffolding can be enclosed with tarpaulins or the Layher Protect System.



Page
64

PILLAR ACCESS – STAIRWAY TOWERS IN MODULAR DESIGN

Layher stairway towers can be used for a wide variety of accesses to bridge pillars or bridge caps. Free-standing or suspended. Compact in a very cramped space, or extensive and comfortable.



Page
66

TEMPORARY REPLACEMENT BRIDGES

Demolition of an existing bridge temporarily makes a hole in the infrastructure. To enable pedestrians, cyclists or site personnel to continue crossing, temporary replacement bridges are the perfect solution for keeping the paths open. Whether they are public paths or only for site personnel.



Page
68

SHORING – TG 60 AND HEAVY-DUTY TOWERS



MORE SOLUTIONS

For further interesting solutions relating to shoring please go to **pages 34 and 54.**

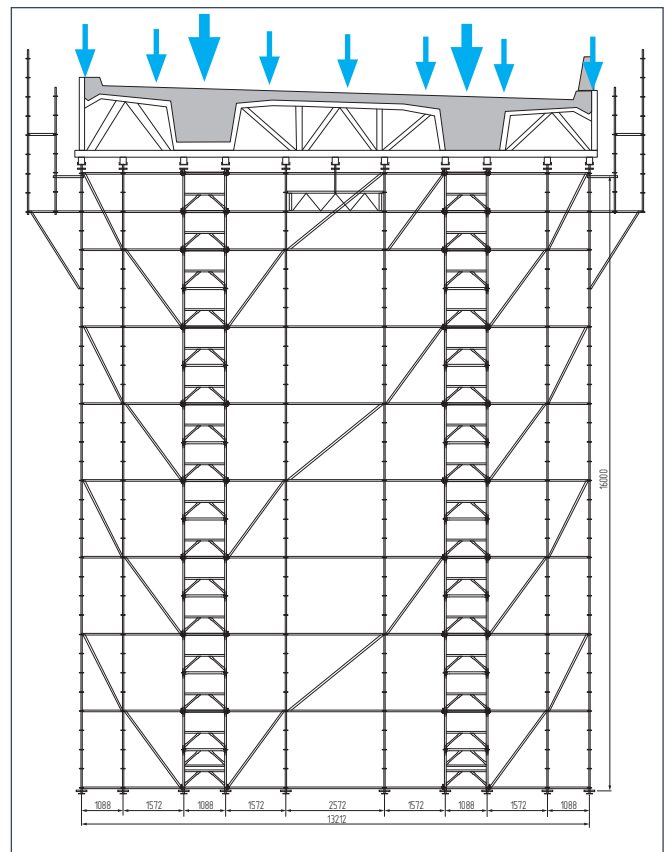
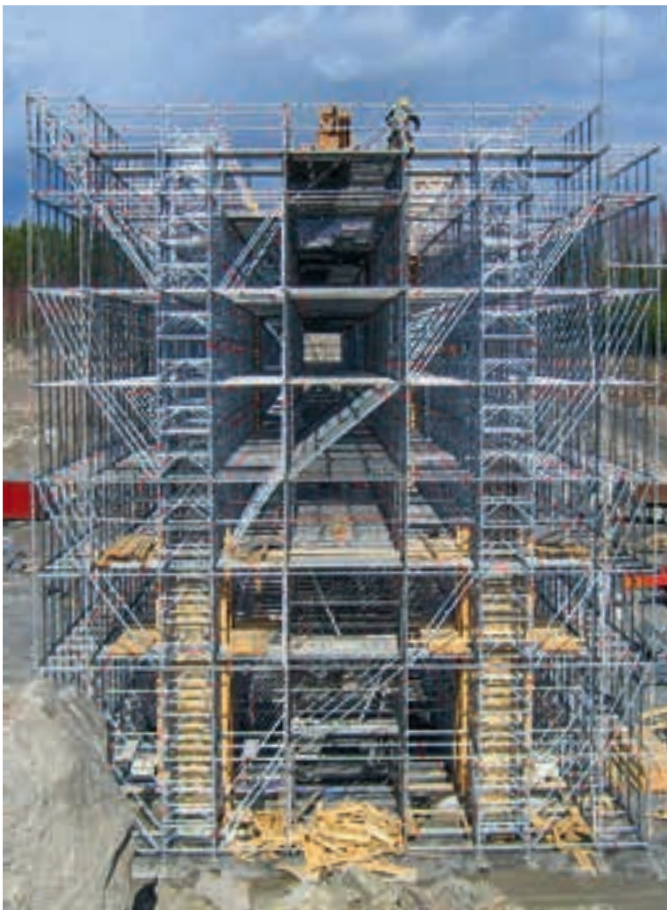

ALLROUND SHORING TG 60

With Allround Shoring TG 60, support structures for concreting work on bridge superstructures can be constructed easily, quickly and safely. The TG 60 frames can be integrated into any Allround birdcage scaffolding to selectively increase its loading capacity. The birdcage scaffolding is always braced using system ledgers and diagonal braces instead of time-consuming tube and coupler connections. Integrated stairway accesses or all-round bracket-mounted walkways can be assembled both easily and quickly. The system dimensions allow any standard components to be combined and installed.

The easy combination with the Allround construction kit permits adaptation to even the most difficult geometries and yet the absorption of very high loads. Combined solutions of shoring and work scaffolding with integrated stairway accesses are possible.



ALLROUND HEAVY-DUTY TOWER / HEAVY-DUTY SUPPORT

Combining four Allround standards using twin edge couplers allows very high point loads of up to around 200 kN (20 t) to be absorbed by the birdcage scaffolding. The individual support can be used vertically, horizontally or inclined.



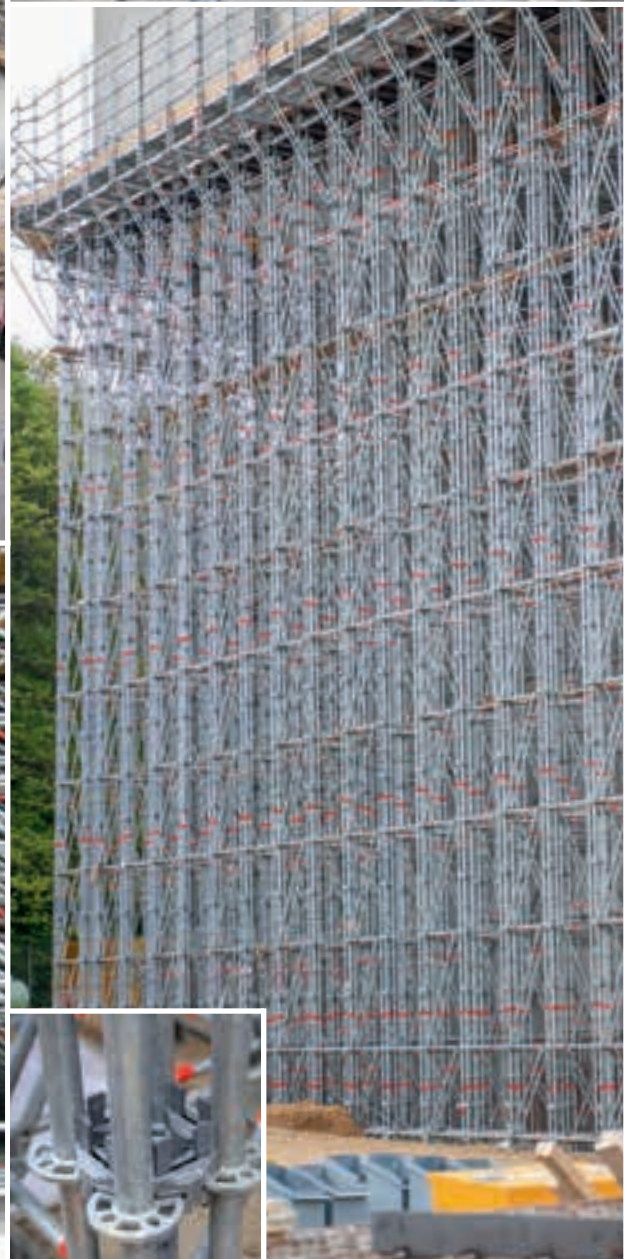

WORK SCAFFOLDING – FREE-STANDING AND SUSPENDED



Work platforms at pillars, bridge caps and as a vantage point can be provided with free-standing or suspended scaffolding. This ensures that every point on the bridge can be reached. For economical scaffolding during modernisation work, the work scaffolding at bridge caps can also be designed mobile. The modular Allround construction kit permits adaptation of works scaffolding to any geometry – regardless of projections, protrusions or supports. Allround Scaffolding is also ideally suited as an access to the formwork carriage.

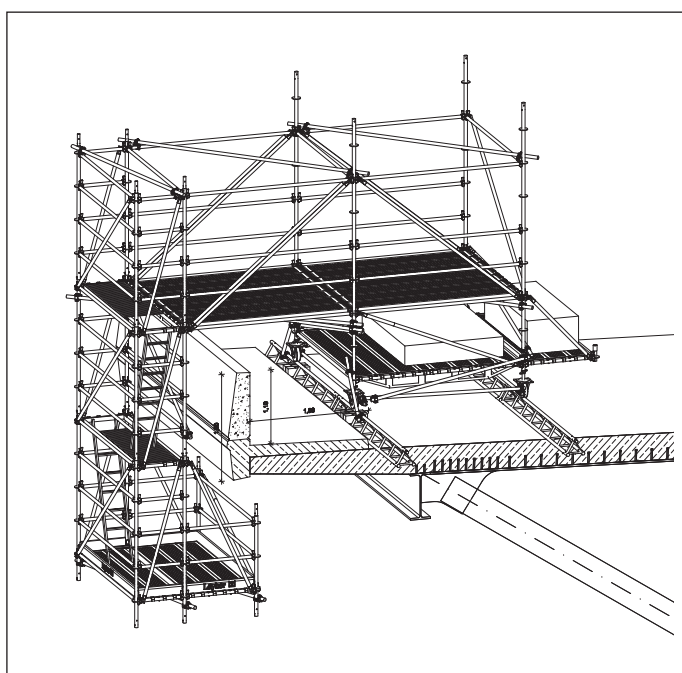

Thanks to the Allround bridging system, work scaffolding can also span even large distances free-standing, without the need for intermediate support for the scaffolding.

PROTECTIVE ENCLOSURES





For protection from dropped working materials or blasting material during corrosion prevention work on bridges with intersecting roads or rail lines, work scaffolding can be enclosed with tarpaulins or the **Layher Protect System**.

The cassettes of the Protect System ensure dust-proof and wind-proof protection here, so that traffic passing below can continue to flow despite modernisation work on bridge pillars, pylons or supporting cables.

For less ambitious enclosures, Layher offers an extensive range of **scaffolding tarpaulins and nets**, which can be assembled quickly and easily thanks to non-system accessory parts.



MORE SOLUTIONS

For further interesting solutions relating to site protection please go to **page 42**.

PILLAR ACCESS – STAIRWAY TOWERS IN MODULAR DESIGN

STAIRWAY TOWERS

Layher stairway towers can be used for a wide variety of accesses to bridges. For building new bridges or modernising existing ones, Layher always had the ideal solution to hand. Free-standing or suspended. Compact in a very cramped space, or extensive and comfortable.

Integration into existing work scaffolding or shoring is also possible. Perfect height adjustment of the entry and exit levels is of course also possible. A comprehensive product range of stairway systems is available for a wide range of access requirements.

ALLROUND MODULAR STAIRWAY TOWER

The Allround modular stairway tower is the perfect solution for access to excavations, unfinished buildings and form-work at sites, and much more besides. Thanks to the 2.21 metre long Allround standard, the stairway tower has no joint-overlapping components and can be pre-assembled safely on the ground, level by level, and then emplaced by crane. Accesses are possible at both the ends and at the sides. You also have the benefit of 20 cm more headroom from a unidirectional stairway than from a conventional one. Thanks to the type approval for an assembly height of up to 115 metres, no further structural strength verifications are necessary.



- Surface area: 1.40 x 2.57 m
- Permissible load capacity: 2.0 kN / m²
- Unidirectional or alternating design possible
- Safer pre-assembly on the ground
- Verified type approval for up to 115 m height
- Conforms to comfort stairway of stairway class B as per DIN EN 1211-1



MORE INFORMATION

For more information on the Allround modular stairway tower, watch the product film at: qrmten.layher.com

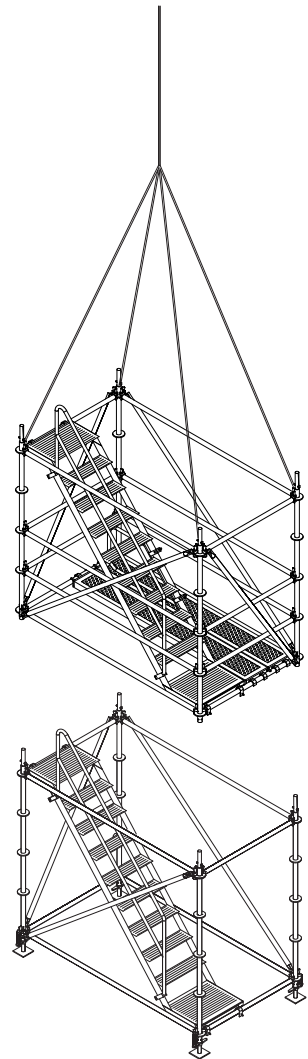



Top: Construction stairway tower integrated into the birdcage scaffolding as the main access and escape route and at the bridge construction site.
 Bottom: Individual and independent stairway towers (Allround modular stairway tower and construction stairway tower 200).



TEMPORARY REPLACEMENT BRIDGES



ALLROUND BRIDGING SYSTEM

The modular-designed Allround bridging system permits the construction of wide-span temporary footbridges with only a few additional parts to Allround Scaffolding.

The Allround bridging system is a modular lattice beam which is connected outside the Allround structure in the system dimensions of the twin wedge coupler.

If the replacement bridge is for use by the public, additional features such as child safety guardrails, enclosures using the Layher Protect System or roofing is available.

Temporary replacement bridges made from Allround Scaffolding and the Allround bridging system can be completely pre-assembled on the ground and then emplaced using a crane on the spot. This reduces the closure times for traffic routes to a minimum. To reduce deformations in the case of wide spans, the beam can be pre-assembled with a deliberate camber.



MORE SOLUTIONS

For further interesting solutions relating to temporary bridges please go to **pages 28 and 84.**



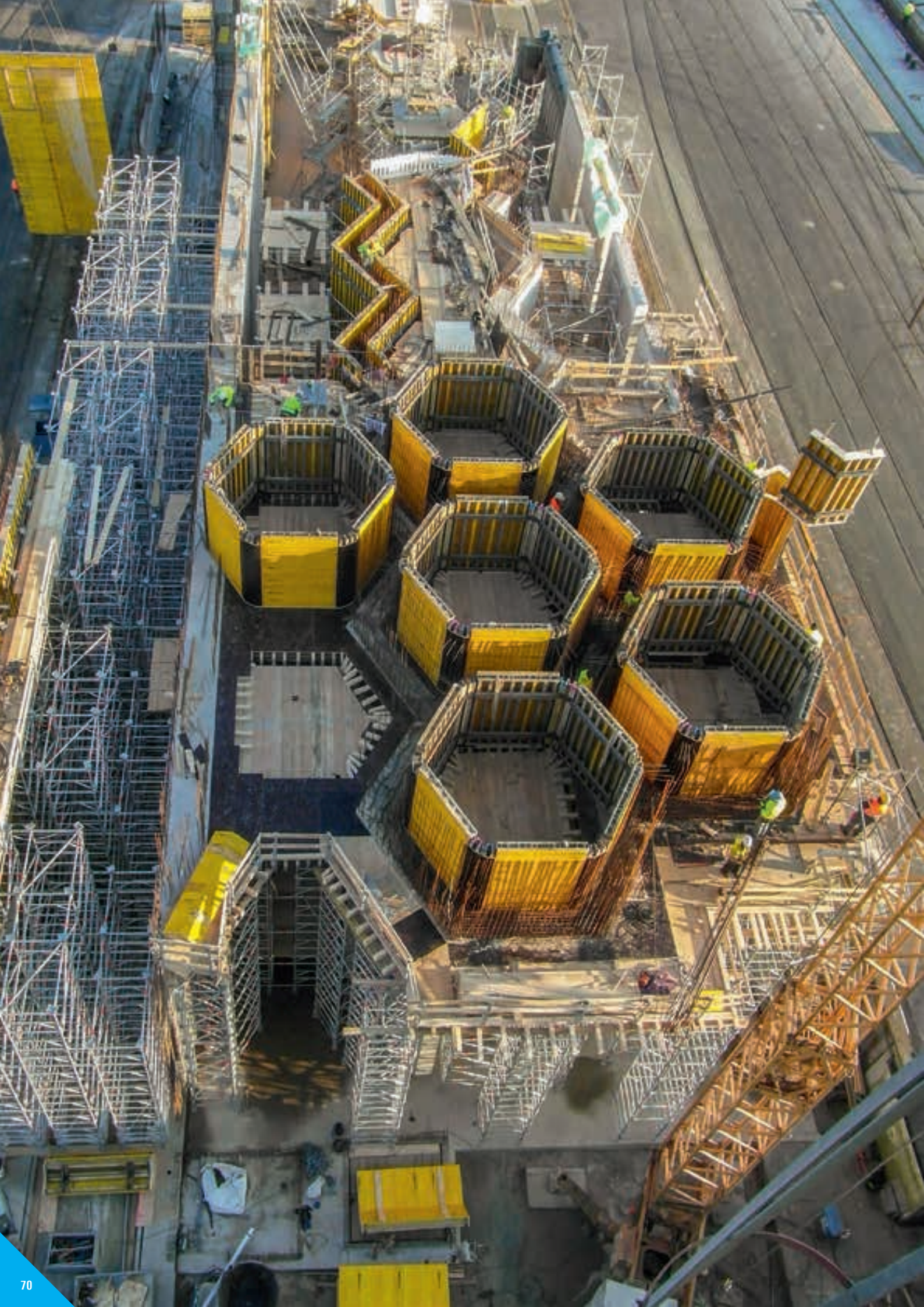

SPECIAL STRUCTURES – PROJECT DESCRIPTIONS

SILO FACILITY, BRAKE

During construction of a new silo in Brake, Allround Shoring TG 60 in combination with Allround Scaffolding proved to be a real all-rounder. To make a massive, hexagonal grid of beams with in-situ concrete, precisely fitting shoring and scaffolding was built. During construction, first the wall formwork was fastened to the scaffolding, so that the otherwise used push-pull props were not needed.

Page
72

PUMPED STORAGE POWER STATION PROJECT, LINTHAL

A persuasive performance during construction of the inlet and outlet structure for the "Linthal 2015" pumped storage project in the heart of the Swiss Alps: supplied just in time and assembled at high speed, the Allround TG 60 Shoring from Layher was able to reliably absorb the high loads of up to 25 tons per meter generated during concreting of ceiling, binding beam and self-supporting wall slab. It permitted optimum adaptation to the difficult geometric situations plus a high degree of safety during assembly.

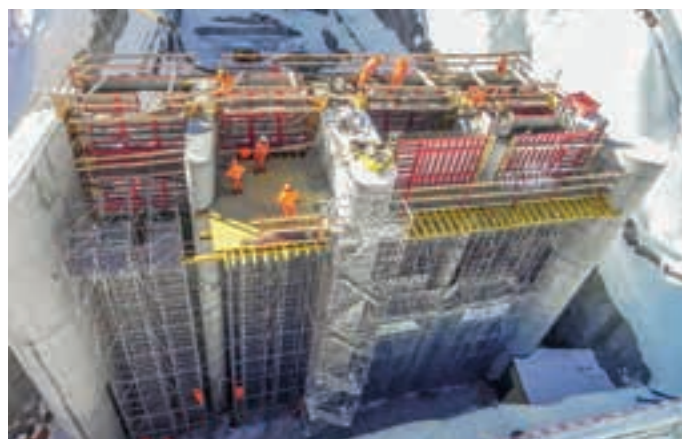
Page
74

DILLINGER HÜTTE STEELWORKS, DILLINGEN

The transmission of heavy loads at a height of 40 metres, plus a height difference of 20 metres, with the surface of the structure being curved inward relative to the ground contact area shown in the ground plan, presented the scaffolding company Gerüstbau Rende with a challenge when assembling a shoring structure. The solution: Allround TG 60 Shoring from Layher. Its modular design ensures that the system can not only be assembled quickly and safely despite the heights involved, but also be optimally adapted to the geometry.

Page
76

SILO FACILITY, HARBURG

Safe dispersal of loads, material-saving and speedy assembly, exact matching to the hexagonal geometry of the structure, plus integration of a site access – the assembly of shoring for construction of a silo with honeycomb-shaped chambers presented the construction company of Max Bögl with challenges. The solution: Allround Shoring TG 60 from Layher. This quick-to-assemble modular system ensures highly flexible shoring construction.

Page
78

SILO FACILITY IN BRAKE



Square, rectangular or hexagonal – thanks to its flexibility in application, Layher's Allround Shoring TG 60 proved to be the ideal solution for building a honeycomb-shaped silo complex around 90 metres high at Brake in Lower Saxony. With this system of modular design, the construction company – Karl Köhler – was able not only to adjust the shoring structure for bracing the wall and ceiling formwork precisely to the geometry, but also to use it both as work/protection scaffolding and as a site access. "An efficient solution", was the verdict of site engineer Frank Lehmann. The new complex for storage and processing of grain, animal feed and oil seed shot up by almost three metres a day. With a total capacity of more than 500,000 tons, it enabled the port of Brake to further consolidate its role as one of Europe's leading agricultural logistics locations – for more future.

THE ADVANTAGES

- ▶ Optimum adjustment to the contour: depending on requirements, assembly of square, rectangular or hexagonal shoring towers for bracing wall and ceiling formwork and /or for concreting the honeycomb-like binding beam some 12 metres up
- ▶ Savings in material and assembly time thanks to variable bay lengths
- ▶ Connecting up of shoring towers using Allround ledgers and diagonal braces in a bolt-free wedge-head connection – no complicated structures using tubes and couplers are needed
- ▶ Rapid repositioning of the shoring towers by crane for the next building phase
- ▶ Layher steel decks as a non-slip work surface
- ▶ Layher access decks for integrated site access
- ▶ Fastening of wall formwork directly to the birdcage scaffolding. As a result, push-pull props could be dispensed with, whole ensuring safer access to the formwork anchors

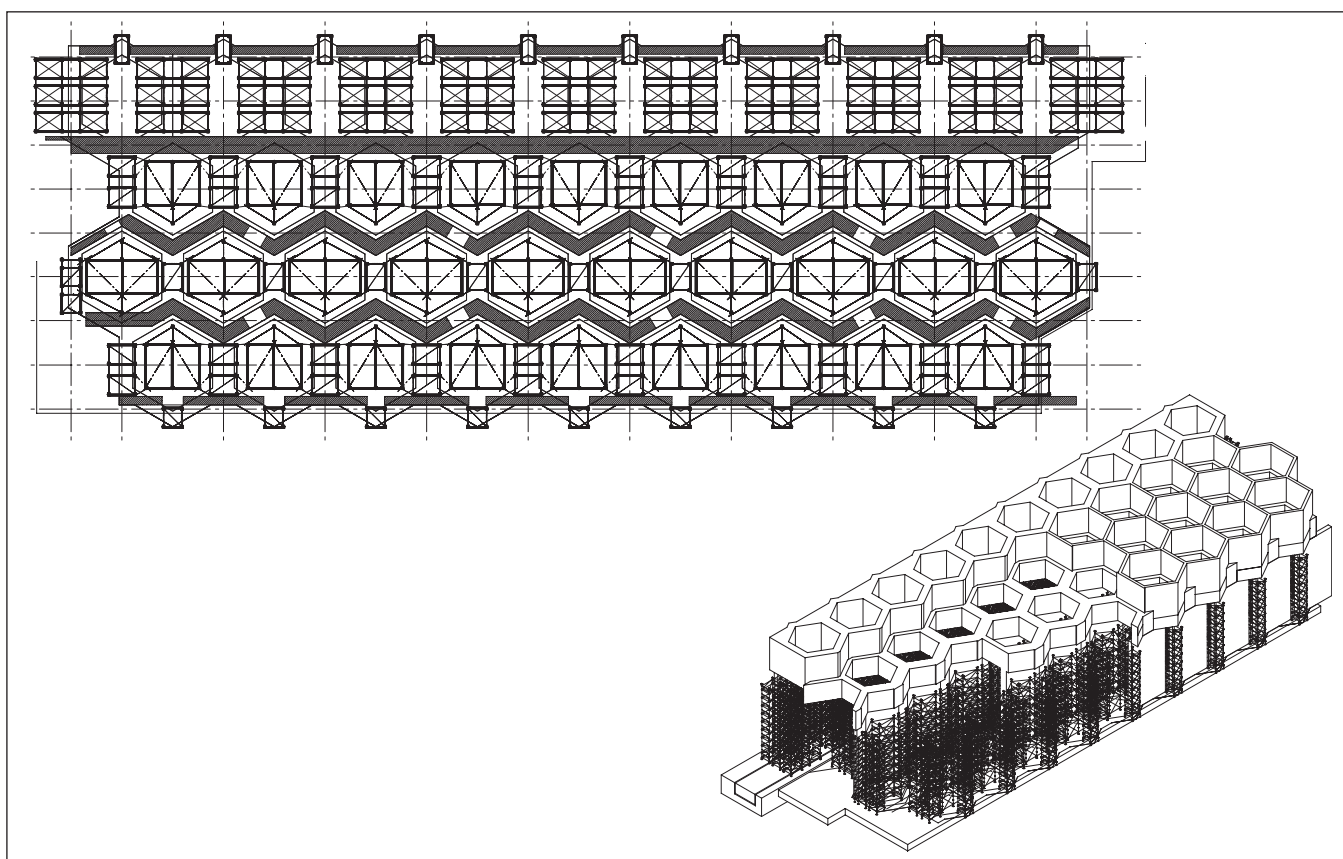

PUMPED STORAGE STATION PROJECT, LINTHAL



In the middle of the Swiss Alps, Switzerland's largest pumped storage power station, "Linthal 2015", is under construction: with caverns larger than the main hall of Zürich's main railway station, and a 1,000 metre long dam. For concreting of ceiling, binding beam and self-supporting wall slab of the inlet and outlet structure, a very strong shoring structure was needed. In view of these challenging requirements, Marti, the construction company involved, carefully selected the new Allround Shoring TG 60 from Layher.

THE ADVANTAGES:

- ▶ Safe dispersion of the heavy loads of up to 25 tons per metre by combining frames
- ▶ Major time saving by use of system scaffolding – system dimensions end the need for complex measurements for the individual towers
- ▶ Rapid and exact geometry adaptation by combination with Allround standard material using wedge-head connectors – without additional connections using tubes and couplers
- ▶ Well thought-out assembly sequence with all-round side protection ensures maximum safety when assembling the shoring towers of up to 17.5 metres in height – for the first time, valid safety regulations can be met in full during shoring construction
- ▶ "Just-in-Time delivery" thanks to rapid material availability, ideal for complicated site logistics using a cable car



THE MAIN FEATURES OF THE DESIGN

- ▶ Ceiling and mounting surface inclined
- ▶ Heavy loads – ceiling thickness 1.70 m
- ▶ Combined frames in area of transverse wall
- ▶ Work platforms material-saving by means of brackets
- ▶ Exact geometrical adjustment to the crater shape
- ▶ Complete solution using standard parts

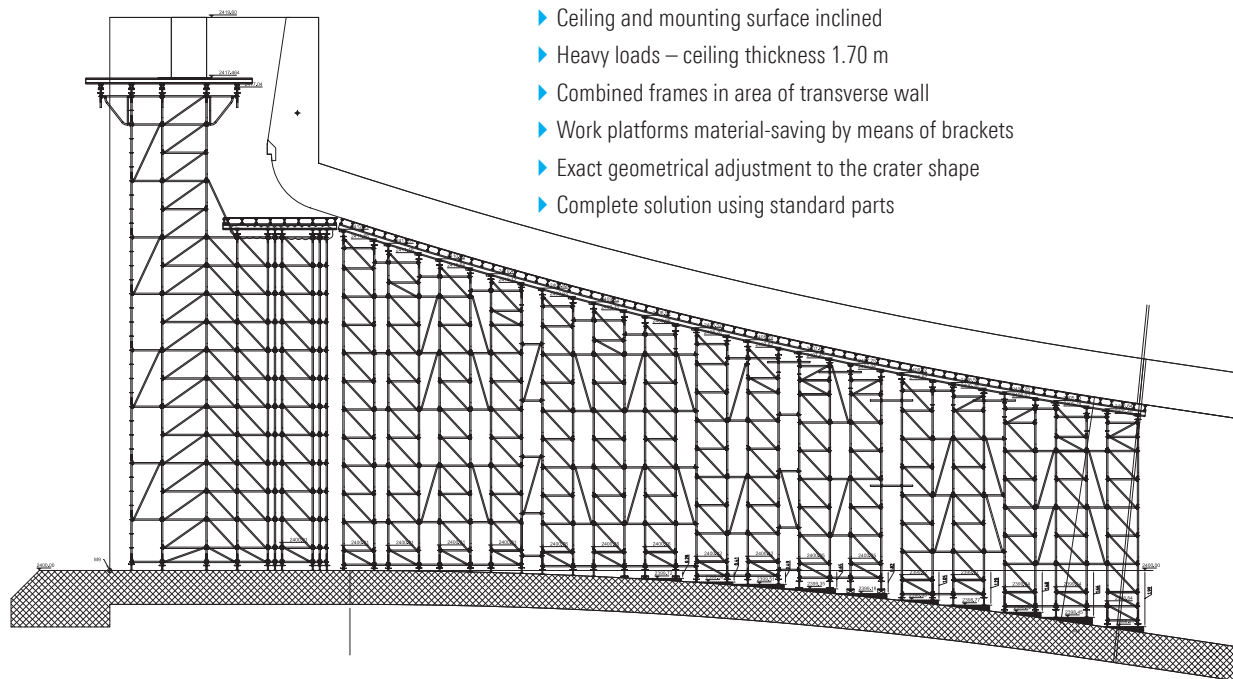

DILLINGER HÜTTE STEELWORKS, DILLINGEN



For the construction of a continuous casting system for the Dillinger Hütte steelworks, concreting a 25 metre long binding beam with a dead weight of 21 tons per metre also required a 40 metre high shoring structure. Thanks to the fast and safe assembly plus flexibility in its possible uses, Allround Shoring TG 60 was the optimum solution for the company Gebr. Rende Gerüstbau GmbH of Saarwellingen. Assembly and dismantling of the around 110 ton overall structure were completed faster than planned despite tight schedules – a vital factor given the investment volume of more than 300 million euros for Europe's leading heavy plate mill.

THE ADVANTAGES:

- ▶ Optimum adjustment to the height difference of 20 metres, curved inward relative to the ground contact area shown in the ground plan
- ▶ Transmission of heavy loads – up to 5.5 tons per standard from a height of 40 metres
- ▶ Material-saving assembly thanks to variable bay lengths and addition of individual frame sections
- ▶ Linking up of the shoring towers using Allround components – without complex structures made of tubes and couplers
- ▶ Economical special solutions: Walkway made of Allround brackets, Allround stairway tower for site access and work platform below the formwork level using Layher scaffolding decks
- ▶ Assembly section by section on the ground and then rapid crane positioning thanks to high fitting precision
- ▶ High degree of safety during placing and removal of formwork thanks to separate deck level underneath the formwork plus walkways and side protection at the edge

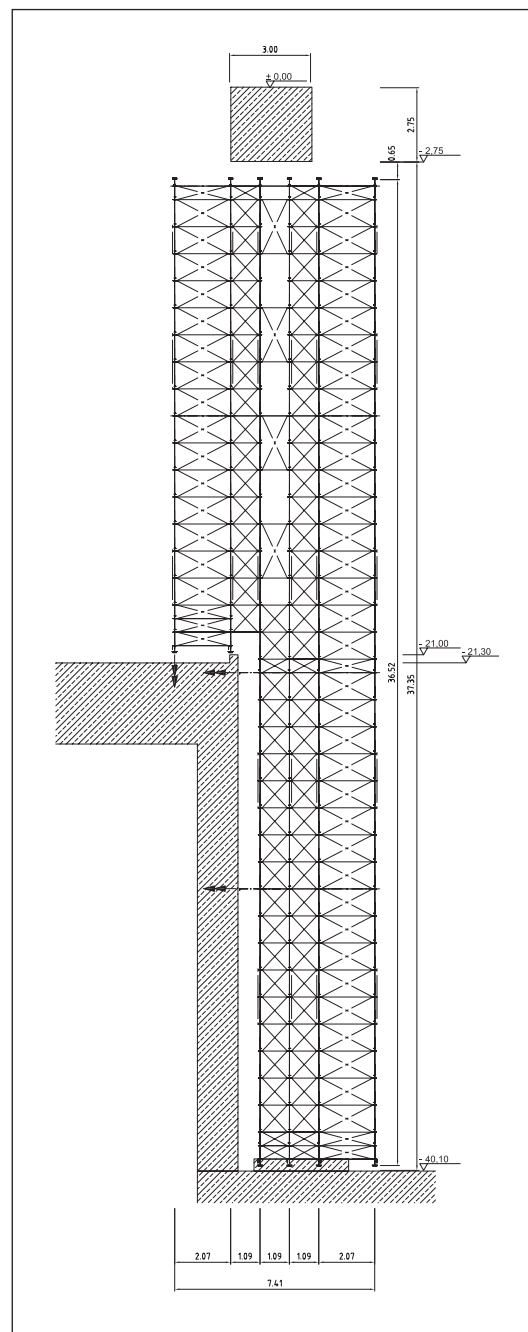

SILO FACILITY IN HARBURG

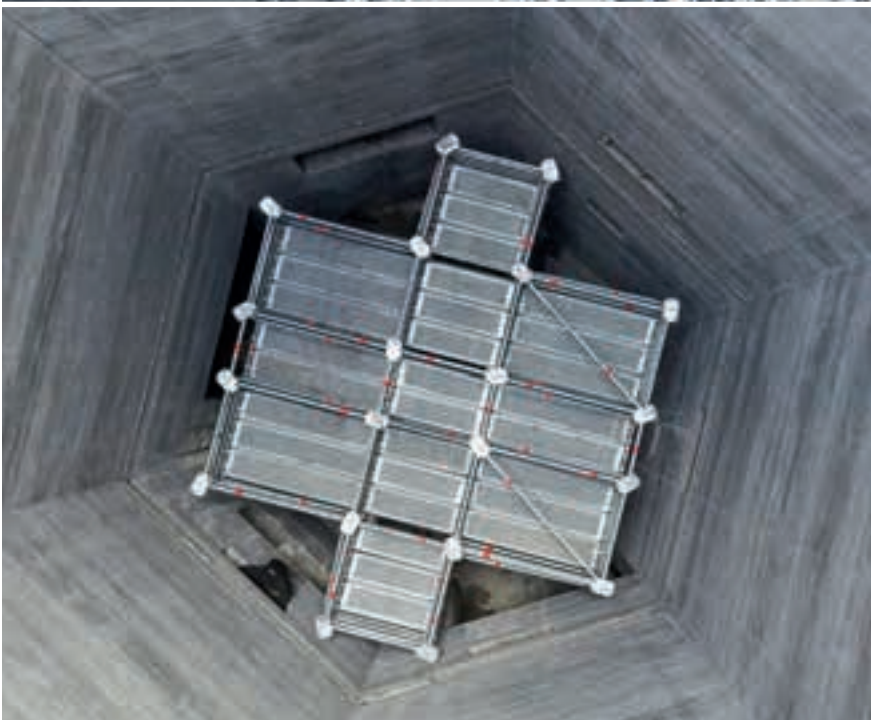

Safer dispersion of loads, material-saving and speedy assembly, exact matching to the hexagonal building geometry, plus integration of a site access – the assembly of shoring to permit subsequent insertion of floors during the construction of a multi-chamber silo with honeycomb-type chambers presented the construction company of Max Bögl with a challenge. The solution: Allround TG 60 Shoring from Layher. Quick to assemble and dismantle, the modular system ensures high flexibility in shoring construction.

THE ADVANTAGES:

- ▶ Load transmission of up to six tons per standard
- ▶ Quick assembly thanks to the reduced number of parts when compared with individual parts, low component weight of max. 18 kilograms, and bolt-free wedge-head connections
- ▶ Full flexibility afforded by variable bay lengths in shoring towers, for optimum use of material and compatibility with the Allround construction kit
- ▶ Problem-free integration of an alternating Allround platform stairway tower into the shoring structure in a very narrow space
- ▶ Safer upright assembly of the up to 14 metre high shoring structures – the assembly sequence automatically provides all-round side protection even without additional components
- ▶ More safety when placing and removing formwork using integrated standard decks

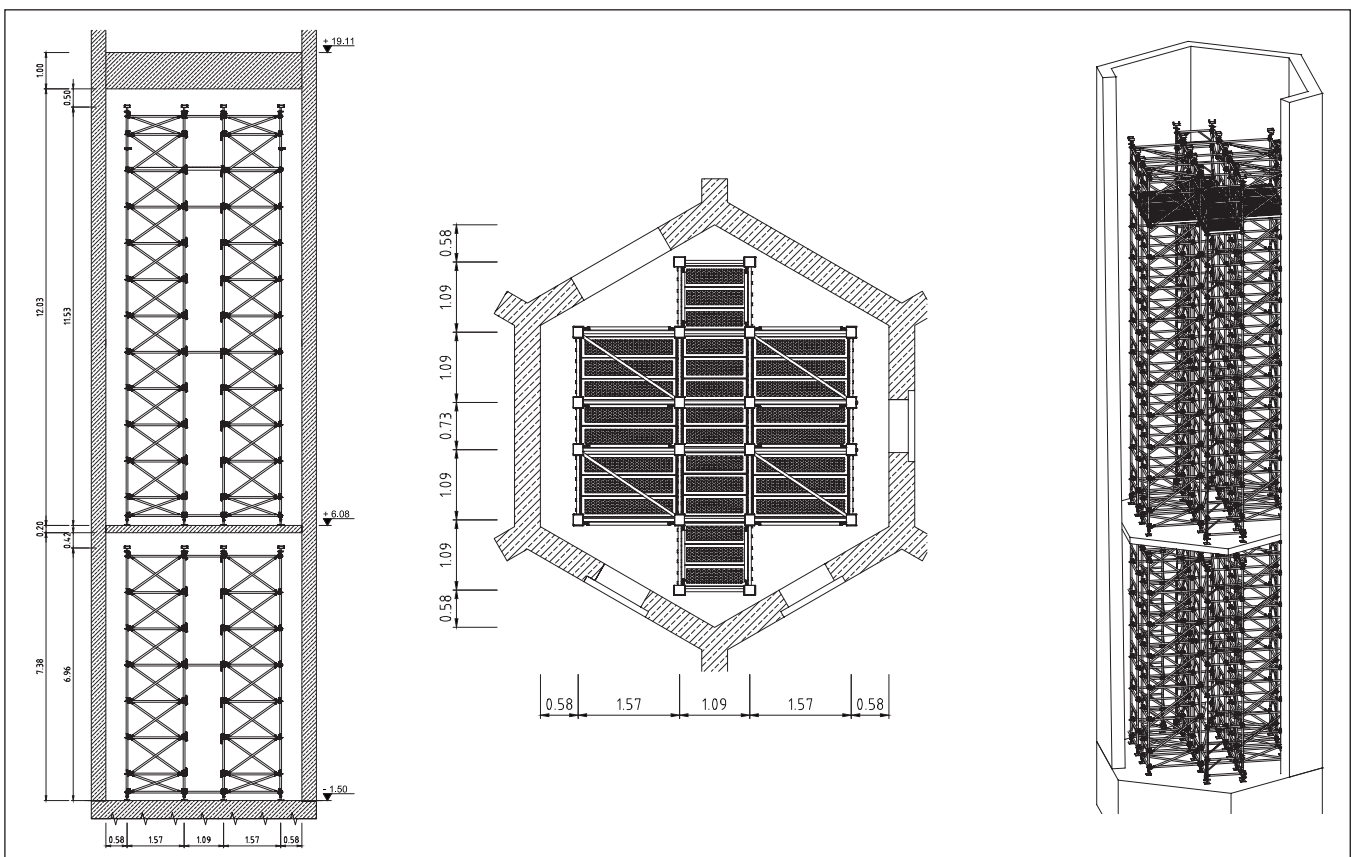



SITE EQUIPMENT

ADVERTISING SIGNS

For advertising signs, structures can be quickly assembled to match various requirements. Adjustment to the terrain presents no problems. Suitable solutions can be found for every location and height – whether the advertising surface is to be panels or tarpaulins.

Page
82

CABLE AND PIPELINE BRIDGES

Supplying the site with electricity, gas and water is essential to a well-functioning construction site. Due to a frequently non-existent infrastructure, pipes have to be routed across roads or rail lines.

Page
83

TRENCH BRIDGES

For access to the unfinished building above the excavation or as an emergency bridge over streams and rivers, only standard Allround parts and steel decks are needed. A 3-part side protection is of course provided.

Page
84

CONTAINER ACCESS

Smart solutions for access to high-level or stacked site containers. In a wide range of versions depending on the requirements and local factors.

Page
85

ADVERTISING SIGNS



ADVERTISING SIGNS

For advertising signs, structures can be quickly assembled to match various requirements using Layer's Allround Scaffolding. Adjustment to the terrain presents no problems. Depending on local factors, the structure can be stabilised using ballast or anchored directly in the foundation. Both temporary and permanent structures can be built.

Ingenious system solutions enhance the appearance of the site or storage area. Recurring structures are more economical.



CABLE AND PIPELINE BRIDGES



CABLE AND PIPELINE BRIDGES

Construction work always involves numerous tasks that can be completed very quickly using Allround Scaffolding. They include the cable or pipeline bridges that increasingly have to be built across traffic routes.

Various solutions are available depending on requirements. From small non-system triangular supports and Allround Scaffolding lattice beam structures, to very strong pipeline bridges made of steel trusses or Allround bridging systems for large spans and high load capacities.



TRENCH BRIDGES



TRENCH BRIDGES

Crane-movable site access using standard Allround Scaffolding material. Adjustment to the prevailing site situation is possible with further Layher products. Safe and economical design that can then be used again for other purposes. Efficient solutions with system scaffolding instead of project-related and time-intensive timber structures.

Standard solution:

Scaffolding widths 1.09 m or 1.40 m

Load class 3 (2.00 kN/m²) in areas closed to the public

Further designs on request.

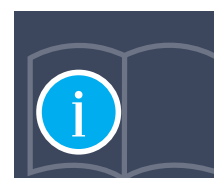

MORE SOLUTIONS

For further interesting solutions relating to temporary bridges please go to **pages 28 and 68.**

CONTAINER ACCESS



CONTAINER ACCESS

Thanks to stairway towers from Layher, a variety of container accesses can be assembled very quickly. Perfectly matched to the requirement on the spot when it comes to surface area, step width etc.



MORE SOLUTIONS

For further interesting solutions relating to stairway towers please go to **pages 26, 52 and 66.**

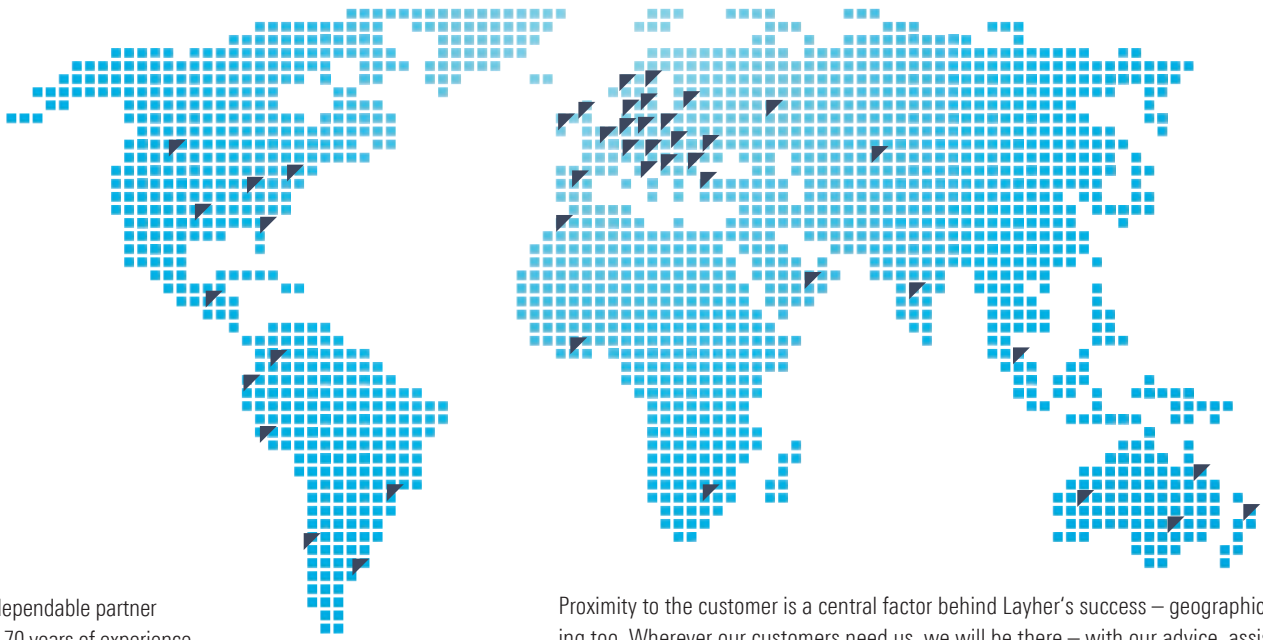

Layher is your dependable partner with more than 70 years of experience. "Made by Layher" always means "Made in Germany" too – and that goes for the entire product range. Superb quality – and all from one source.

Proximity to the customer is a central factor behind Layher's success – geographically speaking too. Wherever our customers need us, we will be there – with our advice, assistance and solutions.

	SpeedyScaf
	Allround Scaffolding
	System-free Accessories
	Protective Systems
	Shoring
	Event Systems
	Rolling Towers
	Ladders



Headquarters in Eibensbach



Plant 2 in Gueglingen

Layher

More Possibilities. The Scaffolding System.

Wilhelm Layher GmbH & Co KG
Scaffolding Grandstands Ladders

Ochsenbacher Strasse 56
74363 Gueglingen-Eibensbach
Germany

Post Box 40
74361 Gueglingen-Eibensbach
Germany
Telephone +49 (0) 71 35 70-0
Telefax +49 (0) 71 35 70-2 65
E-mail export@layher.com
www.layher.com

